



LED Poster

User Manual

Legal Information

About this Document

- This Document includes instructions for using and managing the Product. Pictures, charts, images and all other information hereinafter are for description and explanation only.
- The information contained in the Document is subject to change, without notice, due to firmware updates or other reasons. Please find the latest version of the Document at the Hikvision website (<https://www.hikvision.com>). Unless otherwise agreed, Hangzhou Hikvision Digital Technology Co., Ltd. or its affiliates (hereinafter referred to as "Hikvision") makes no warranties, express or implied.
- Please use the Document with the guidance and assistance of professionals trained in supporting the Product.

About this Product

This product can only enjoy the after-sales service support in the country or region where the purchase is made.

Acknowledgment of Intellectual Property Rights

- Hikvision owns the copyrights and/or patents related to the technology embodied in the Products described in this Document, which may include licenses obtained from third parties.
- Any part of the Document, including text, pictures, graphics, etc., belongs to Hikvision. No part of this Document may be excerpted, copied, translated, or modified in whole or in part by any means without written permission.
- **HIKVISION** and other Hikvision's trademarks and logos are the properties of Hikvision in various jurisdictions.
- Other trademarks and logos mentioned are the properties of their respective owners.



The terms HDMI, HDMI High-Definition Multimedia

Interface, HDMI Trade dress and the HDMI Logos are trademarks or registered trademarks of HDMI Licensing Administrator, Inc.

LEGAL DISCLAIMER

- TO THE MAXIMUM EXTENT PERMITTED BY APPLICABLE LAW, THIS DOCUMENT AND THE PRODUCT DESCRIBED, WITH ITS HARDWARE, SOFTWARE AND FIRMWARE, ARE PROVIDED "AS IS" AND "WITH ALL FAULTS AND ERRORS". HIKVISION MAKES NO WARRANTIES, EXPRESS OR IMPLIED, INCLUDING WITHOUT LIMITATION, MERCHANTABILITY, SATISFACTORY QUALITY, OR

FITNESS FOR A PARTICULAR PURPOSE. THE USE OF THE PRODUCT BY YOU IS AT YOUR OWN RISK. IN NO EVENT WILL HIKVISION BE LIABLE TO YOU FOR ANY SPECIAL, CONSEQUENTIAL, INCIDENTAL, OR INDIRECT DAMAGES, INCLUDING, AMONG OTHERS, DAMAGES FOR LOSS OF BUSINESS PROFITS, BUSINESS INTERRUPTION, OR LOSS OF DATA, CORRUPTION OF SYSTEMS, OR LOSS OF DOCUMENTATION, WHETHER BASED ON BREACH OF CONTRACT, TORT (INCLUDING NEGLIGENCE), PRODUCT LIABILITY, OR OTHERWISE, IN CONNECTION WITH THE USE OF THE PRODUCT, EVEN IF HIKVISION HAS BEEN ADVISED OF THE POSSIBILITY OF SUCH DAMAGES OR LOSS.

- YOU ACKNOWLEDGE THAT THE NATURE OF THE INTERNET PROVIDES FOR INHERENT SECURITY RISKS, AND HIKVISION SHALL NOT TAKE ANY RESPONSIBILITIES FOR ABNORMAL OPERATION, PRIVACY LEAKAGE OR OTHER DAMAGES RESULTING FROM CYBER-ATTACK, HACKER ATTACK, VIRUS INFECTION, OR OTHER INTERNET SECURITY RISKS; HOWEVER, HIKVISION WILL PROVIDE TIMELY TECHNICAL SUPPORT IF REQUIRED.
- YOU AGREE TO USE THIS PRODUCT IN COMPLIANCE WITH ALL APPLICABLE LAWS, AND YOU ARE SOLELY RESPONSIBLE FOR ENSURING THAT YOUR USE CONFORMS TO THE APPLICABLE LAW. ESPECIALLY, YOU ARE RESPONSIBLE, FOR USING THIS PRODUCT IN A MANNER THAT DOES NOT INFRINGE ON THE RIGHTS OF THIRD PARTIES, INCLUDING WITHOUT LIMITATION, RIGHTS OF PUBLICITY, INTELLECTUAL PROPERTY RIGHTS, OR DATA PROTECTION AND OTHER PRIVACY RIGHTS. YOU SHALL NOT USE THIS PRODUCT FOR ANY PROHIBITED END-USES, INCLUDING THE DEVELOPMENT OR PRODUCTION OF WEAPONS OF MASS DESTRUCTION, THE DEVELOPMENT OR PRODUCTION OF CHEMICAL OR BIOLOGICAL WEAPONS, ANY ACTIVITIES IN THE CONTEXT RELATED TO ANY NUCLEAR EXPLOSIVE OR UNSAFE NUCLEAR FUEL-CYCLE, OR IN SUPPORT OF HUMAN RIGHTS ABUSES.
- IN THE EVENT OF ANY CONFLICTS BETWEEN THIS DOCUMENT AND THE APPLICABLE LAW, THE LATTER PREVAILS.



© Hangzhou Hikvision Digital Technology Co., Ltd. All rights reserved.

Applicable Models

This manual is applicable to the LED Poster.

Symbol Conventions

The symbols that may be found in this document are defined as follows.

Symbol	Description
 Note	Provides additional information to emphasize or supplement important points of the main text.
 Caution	Indicates a potentially hazardous situation, which if not avoided, could result in equipment damage, data loss, performance degradation, or unexpected results.
 Danger	Indicates a hazard with a high level of risk, which if not avoided, will result in death or serious injury.

Safety Instructions

Caution

- To reduce the risk of fire or electric shock, please do not expose the device to rain or humid environment.
- The device may generate radio interference in indoor environment. Necessary precautions may be required.
- Electric discharge may last for a short period of time after the power is shut down. Please wait two minutes after the power is shut down before operating the device.
- To avoid the risk of electric shock, please do not operate when the power is on.
- Please do not plug and unplug the power cable when the power is on.
- Ensure correct voltage and wiring of the terminals for connection to mains supply.
- The device is only suitable for installation on the concrete or non-flammable surfaces, to prevent molten material from dripping to the bottom during fire caused by internal failure.
- Keep 90 degrees when moving and using the device.
- Do not place anything containing liquid on the device to avoid the risk of fire or electric shock caused by liquid-splashing.
- Install the device no more than 5 mm away from the wall or other metal racks in case of lamp board drop resulting in electric shock.
- After installation, there should be no openings around the LED module. The bottom bracket under the wire outlet position should completely cover the bottom hole only to let the wire out,

to prevent the molten material from dripping to the bottom during fire caused by internal failure.

- To ensure safety, the installation parts and the wall should support four times the weight of the device.

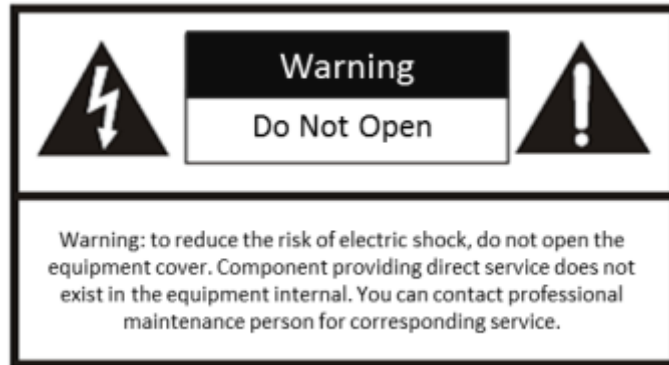

Warning

- In the use of the product, you must be in strict compliance with the electrical safety regulations of the nation and region.
- The device shall not be exposed to water dripping or splashing, and no objects filled with liquids, such as vases, shall be placed on the device.
- Provide a surge suppressor at the inlet opening of the device under special conditions such as the mountain top, iron tower, and forest.
- The protective grounding of the device should be reliably connected to the building protective grounding.
- Do not touch the bare components (such as the metal contacts of the inlets) and wait for at least 5 minutes, since electricity may still exist after the device is powered off.
- + identifies the positive terminals of the device which is used with, or generates direct current, and - identifies the negative terminal(s) of the device which is used with, or generates direct current.
- No naked flame sources, such as lighted candles, should be placed on the device.
- Install the device according to the instructions in Quick Start Guide.
- To prevent injury, this device must be securely attached to the installation surface in accordance with the installation instructions.
- Never place the device in an unstable location. The device may fall, causing serious personal injury or death.
- The additional force shall be equal to three times the weight of the device but not less than 50 N. The device and its associated mounting means shall remain secure during the installation. After the installation, the device, including any associated mounting plate, shall not be damaged.
- The interface varies with the models. Please refer to the product datasheet for details.

- If the device needs to be wired by yourself, select the corresponding wire to supply power according to the electric parameters labeled on the device. Strip off wire with a standard wire stripper at corresponding position. To avoid serious consequences, the length of stripped wire shall be appropriate, and conductors shall not be exposed.
- Make sure that the power has been disconnected before you wire, install, or disassemble the device.
- If smoke, odor, or noise arises from the power supply or device, immediately turn off the power, unplug the power cable, and contact the service center.
- The equipment has been designed, when required, modified for connection to an IT power distribution system.
- NEVER place items that might tempt children to climb, such as toys and remote controls, on the top of the equipment.
- CAUTION: This bracket is intended for use only with LED display unit. Use with other equipment may result in instability causing injury.
- This device is suitable for mounting on concrete or other non-combustible surface only to avoid fire hazard.
- The power supply or device must be connected to an earthed mains socket-outlet.
- High voltage for the power supply. Do not disassemble it.
- An all-pole mains switch shall be incorporated in the electrical installation of the building.
- A readily accessible disconnect device shall be incorporated external to the equipment, rated 220/230/240 VAC, 6 A for each device. A single device is recommended for AC 220 V/ 230 V/ 240 V, 6 A circuit breakers. When multiple devices are superimposed, a suitable circuit breaker should be selected according to the total rated current, but it must not exceed the building equipped circuit specifications.
- To reduce the risk of electric shock, install protective shield on the exposed connector after installing LED screen.
- The power supply or device must be connected to an earthed mains socket-outlet.
- High voltage for the power supply. Do not disassemble it.
- CAUTION: This device is for use only with LED bracket. Use with other (carts, stands, or carriers) may result in instability causing injury.
- The device external wiring connected to the hazardous live terminals requires installation by an instructed person.
- To reduce the risk of electric shock, install protective shield on the exposed connector after installing LED screen.
- Disconnect the power plug before installing the protective shield.
- Disconnect the power plug before maintenance.
- Make sure the power supply is well-grounded.
- The external wire connection between device and hazardous electronic terminals should be operated by professionals.
- Please strictly follow the installation method in this guide.

- To prevent injury, the device must be securely fixed to the ground, wall, ceiling, or steel frame. The all-in-one rack should be fixed to the ground with expansion screws.
- The supporting rack can only be used with the device. Using it with other devices may cause instability and injury.
- The device can only be used with the supporting rack. Using it with other equipment (such as a cart, shelf, or handling device) may cause instability and injury.
- This is a class A product and may cause radio interference in which case the user may be required to take adequate measures.

TABLE OF CONTENTS

Chapter 1 Introduction	1
1.1 Product Overview	1
1.2 Features	1
Chapter 2 Device Installation	2
2.1 Device Type.....	2
2.2 Device Structure	3
2.3 Regular Use for Retail Model	3
2.4 (Optional) Install Wall-Mounted Bracket for A Single Device	4
2.5 (Optional) Install Mobile Base for A Single Device.....	10
2.6 Splice Multiple Devices	22
2.6.1 Standard Splicing for Multiple Devices	22
2.6.2 Wall-Mounted Splicing for Multiple Devices	25
2.6.3 Mobile Base Splicing for Multiple Devices	28
2.7 Device Wiring.....	33
Chapter 3 Prerequisite Configuration.....	35
3.1 Activate and Log In to the Device	35
3.2 Lighten the Device	38
3.2.1 Import Receiving Card Parameters	38
3.2.2 Lighten the Screen	38
3.2.3 Firstly Correct Receiving Cards	40
Chapter 4 Screen Parameters Configuration	41
4.1 Correct Receiving Cards	41
4.2 Configure Signal Source Parameters.....	43
4.3 Configure Image Effect	44
4.3.1 Configure Display Effect of Screen	44
4.3.2 Configure Startup Image	46
4.3.3 Configure No Signal Images	47
4.3.4 Configure Screen Splicing.....	48
4.4 Configure General Parameters	49
4.4.1 Configure Time for the Device	49
4.4.2 Configure Hot Spare for the Device	49
4.4.3 Configure Alarms	49
4.4.4 Configure Timed Parameters	50
4.5 Configure Network Parameters	51
4.5.1 Configure Wired Network Address	51
4.5.2 Configure Wireless Network Address	52
4.5.3 Configure Bluetooth.....	53
4.5.4 Configure Hot Spot.....	54
4.6 Configure Auto Dehumidification	55
4.7 Configure Loading Mode	56

4.8 Configure Cascading/Self-Splicing	57
Chapter 5 Screen Content Configuration	58
5.1 Create and Play One Program	58
5.1.1 Create and Play One Normal Program	58
5.1.2 Create and Play One Ultra-Long-Screen Program	60
5.1.3 Set Other Program Parameters	63
5.2 Create and Play Multiple Programs	64
5.3 Manage Materials	68
5.3.1 Configure Material Parameters	68
5.3.2 Delete Materials	70
Chapter 6 Device Maintenance	72
6.1 View Device Status	72
6.2 Quickly Maintain a Receiving Card	74
6.3 Test Screen Condition	75
6.4 Maintain the System	75
Chapter 7 Screen Configuration (Other Pages)	79
7.1 Use the OSD Page	79
7.2 Use GUI Page	81
7.2.1 GUI Page Overview	81
7.2.2 Splice Screens on GUI Page	85
7.2.3 Set Playing Schedule	93
7.2.4 Edit Device Parameters	96

Chapter 1 Introduction

1.1 Product Overview

LED Poster display (hereinafter referred to as the device) features a sleek black alloy construction with an ultra-thin and portable design. Its magnetic butterfly bezels enable effortless multi-device assembly for seamless splicing. Capable of standalone operation or rapid horizontal splicing of multiple devices to achieve 1080P standard resolution. The device delivers dynamic video content with exceptional brightness and contrast ratio, maintaining premium visual quality across wide viewing angles.

1.2 Features

- The device features a highly integrated and compatible cabinet design with a sleek and lightweight structure, incorporating magnetic butterfly bezels that enables rapid horizontal splicing for seamless displays.
- Equipped with proprietary lossless image processing and ultra-low grayscale control technology, it can deliver delicate and smooth images and exceptional dynamic color reproduction.
- The device supports multi-channel screen content management via GUI page, USB interface and web page as well as remote controlling and managing playback content.
- Its fully self-developed display-control system ensures stable, secure, and controllable operation. It also supports quick maintenance or replacement of modular components. The lamp board supports front maintenance and single lamp repair.
- Support multi-device cascading to display the screen content without additional controllers.
- Versatile installation options: mobile base mounting, or wall-mounting.

Chapter 2 Device Installation

2.1 Device Type

The devices are divided into two types: retail and rental models. The unboxing status varies depending on the different models, as shown in the following figure.

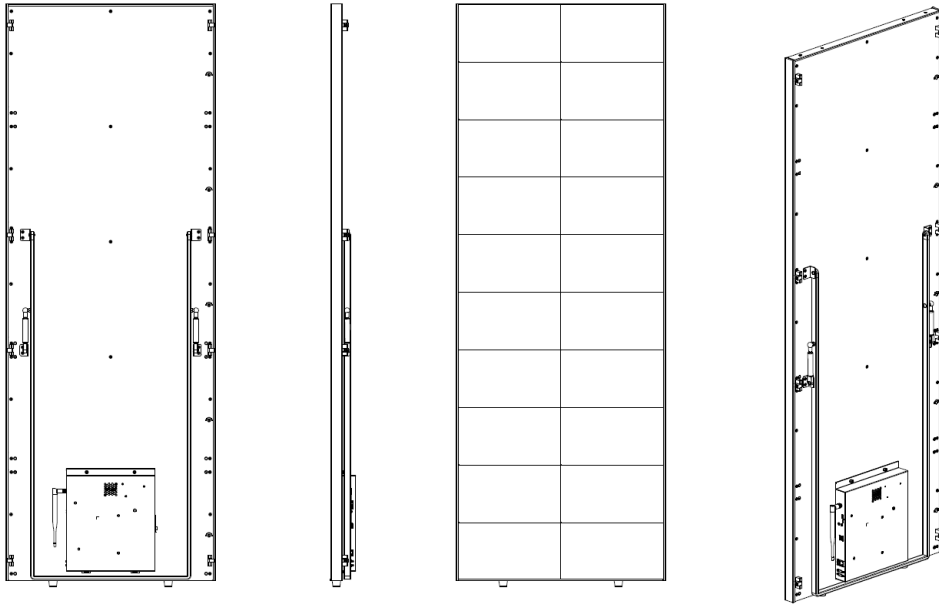

Figure 2-1 Unboxing Status (Retail)

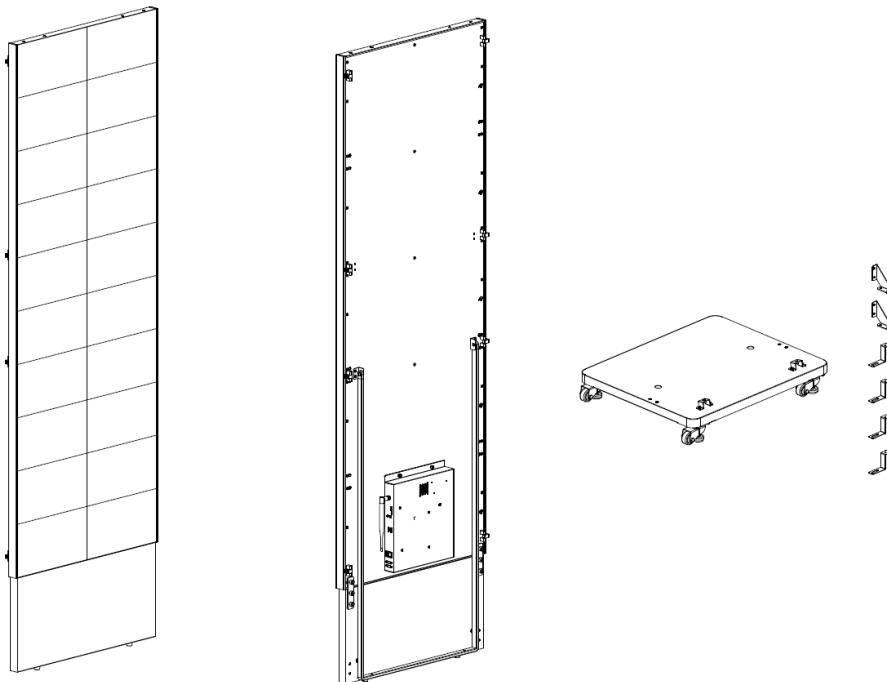

Figure 2-2 Unboxing Status (Rental)

2.2 Device Structure

The device consists of two parts: the display and the tilt bracket. When shipped, the device is equipped with a short tilt bracket by default. Optional accessories include a mobile base or wall-mounted bracket.

- Retail models can be optionally equipped with mobile base or wall-mounted bracket.
- Rental models can be optionally equipped with wall-mounted bracket.

When installing the mobile base, the short tilt bracket must be replaced with a new tilt bracket gone with the mobile base; when installing the wall-mounted bracket, the short tilt bracket must be removed.

2.3 Regular Use for Retail Model

For regular use of the retail models, open the tilt bracket, and pull it outward in the direction of the arrow to automatically spring it open.

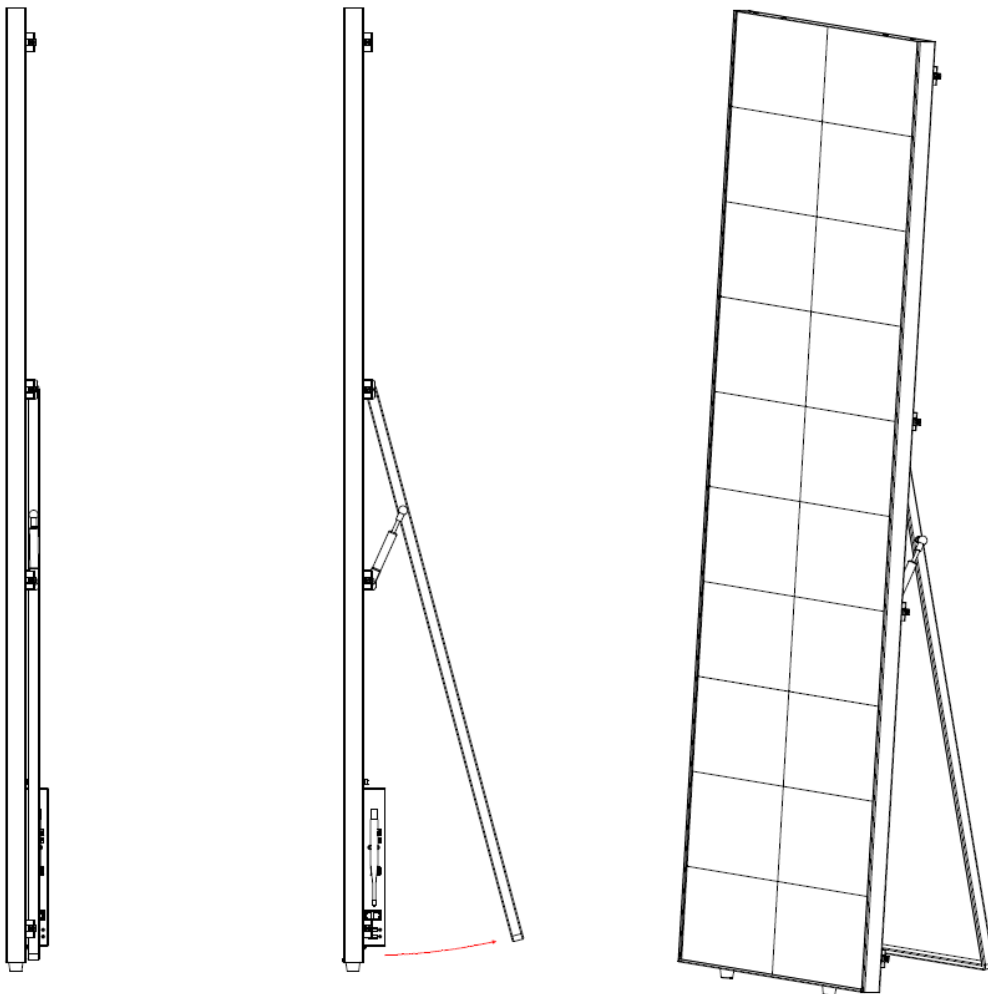

Figure 2-3 Regular Use for Retail Model

2.4 (Optional) Install Wall-Mounted Bracket for A Single Device

The following steps will give a detailed process of installing the wall-mounted brackets for a single device taking a retail device as an example.

Table 2-1 Wall-Mounted Bracket Components

Accessories	Quantity	Accessories	Quantity
Wall-mounted bracket	2	M8 × 80 expansion screw	4
Wall-mounted hook	2	M8 × 12 screw	8
M4 × 25 screw	4	/	/

Required main accessories:

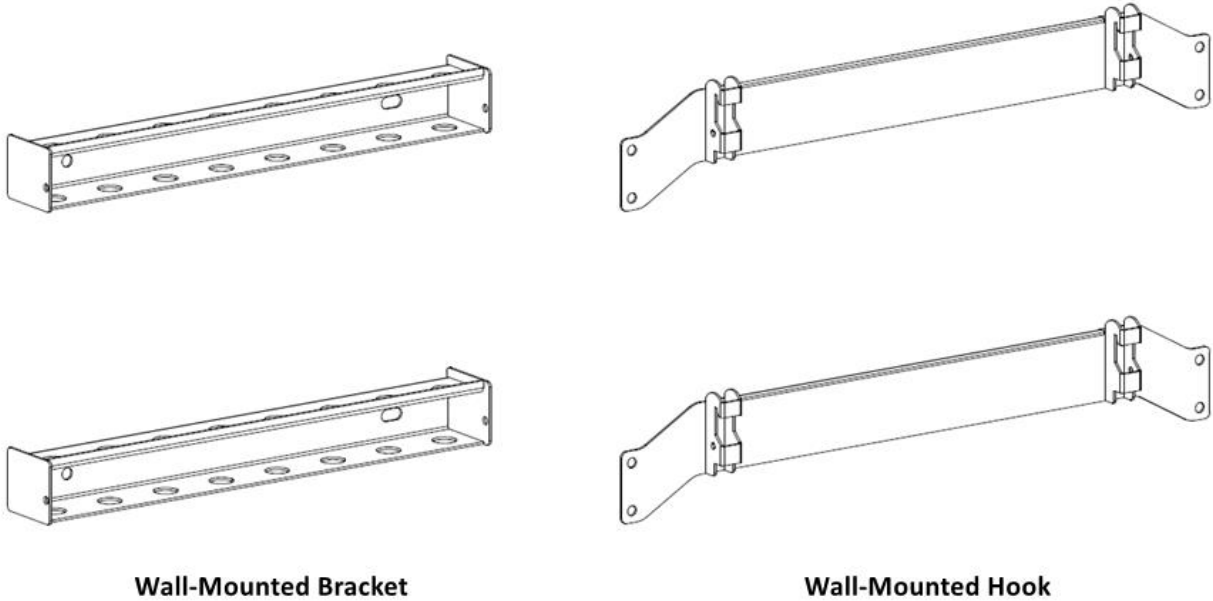

Figure 2-4 Wall-Mounted Installation Accessories

Step 1 Install four M8 × 80 expansion bolts on the wall according to the dimensions shown in the figure, and then fix the wall-mounted bracket onto the wall.

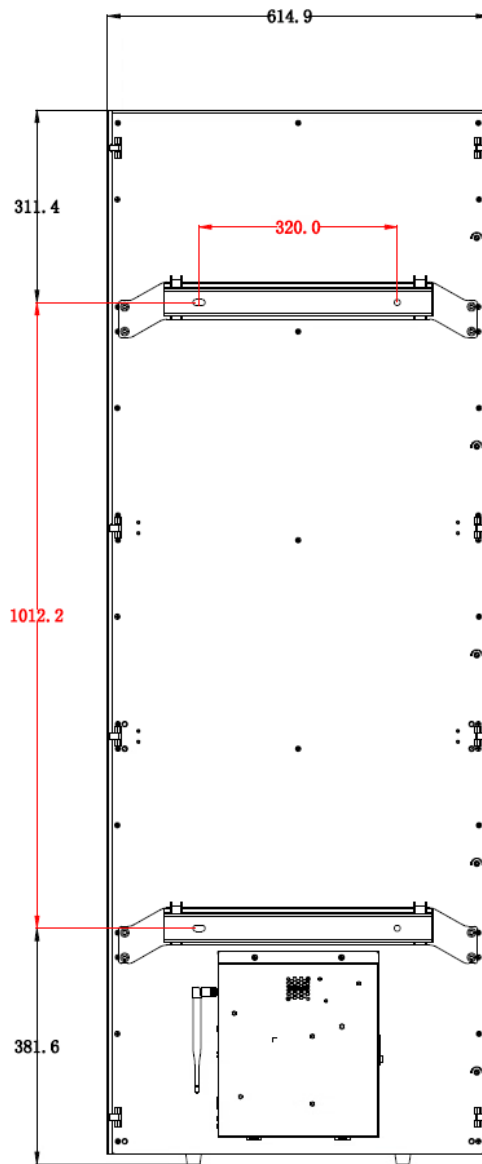

Figure 2-5 Installation Dimensions Requirement

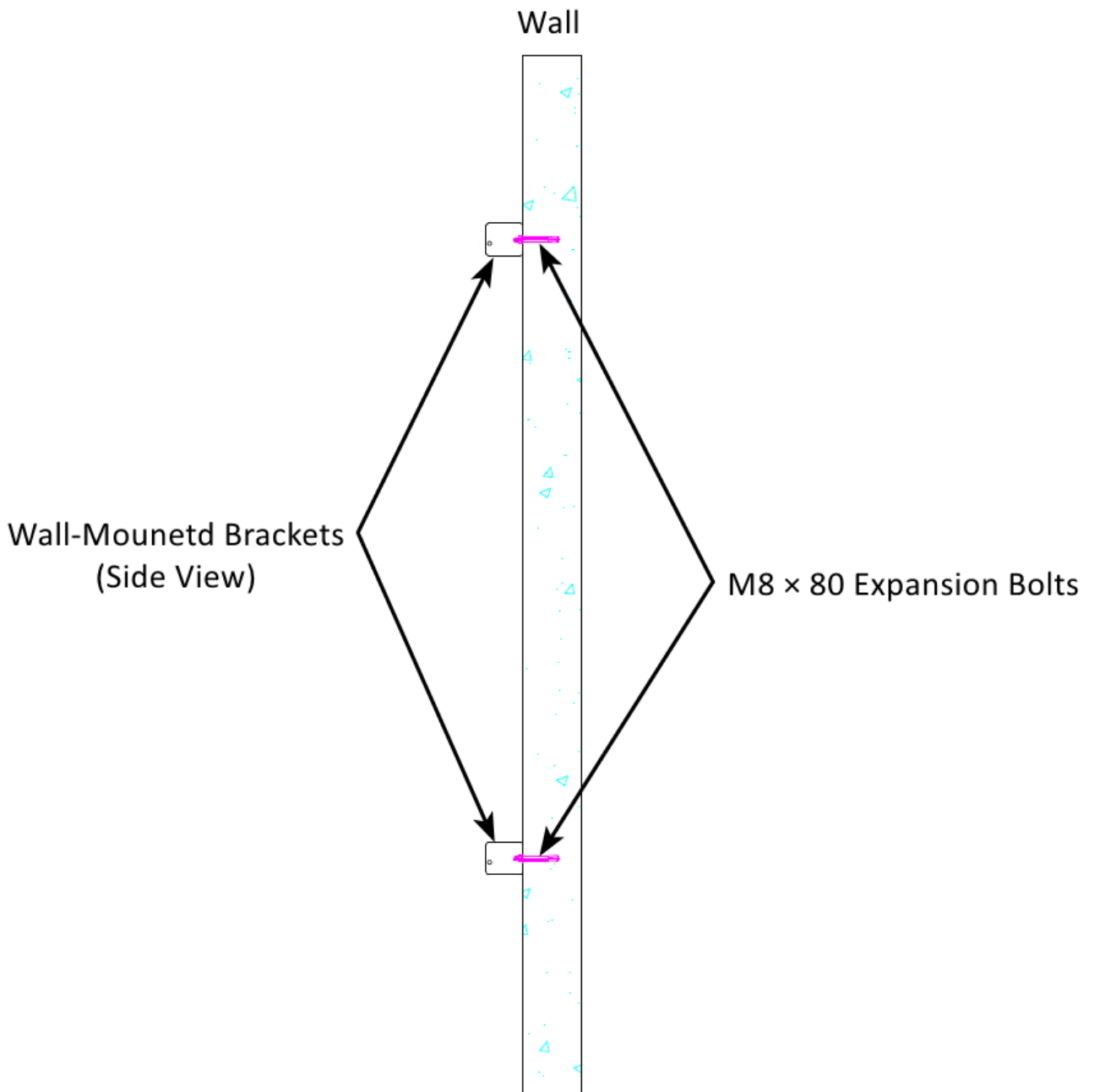

Figure 2-6 Install Wall-Mounted Brackets onto the Wall (Side View)

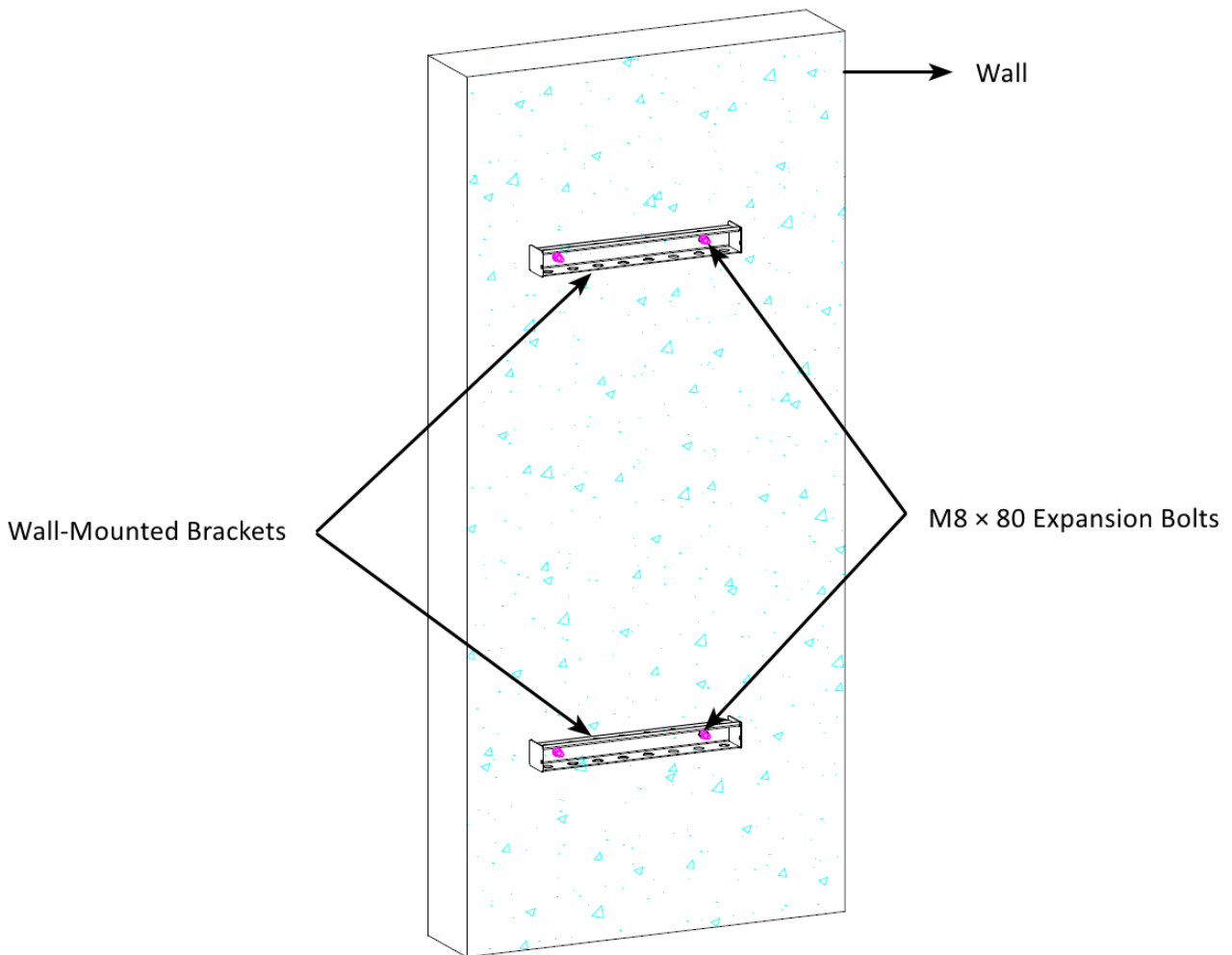

Figure 2-7 Install Wall-Mounted Brackets onto the Wall

⚠ Caution

- The wall for wall mounting must be a load-bearing wall, and the surface must be vertical and flat.
- The wall thickness must exceed the length of the installed screws. The reserved installation area must be larger than that of the device.

Step 2 Use a screwdriver to remove the tilt bracket pre-installed on the device.

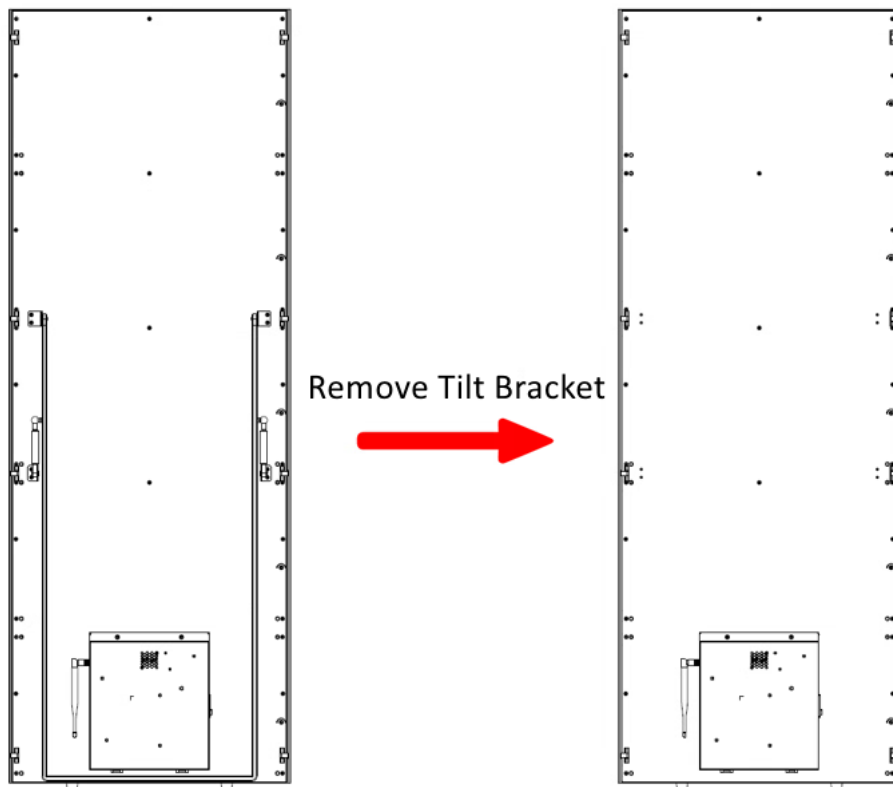

Figure 2-8 Remove the Tilt Bracket

Step 3 Secure two wall-mounted hooks to the back of the display with eight M8 screws, aligning them with the wall-mounted holes.

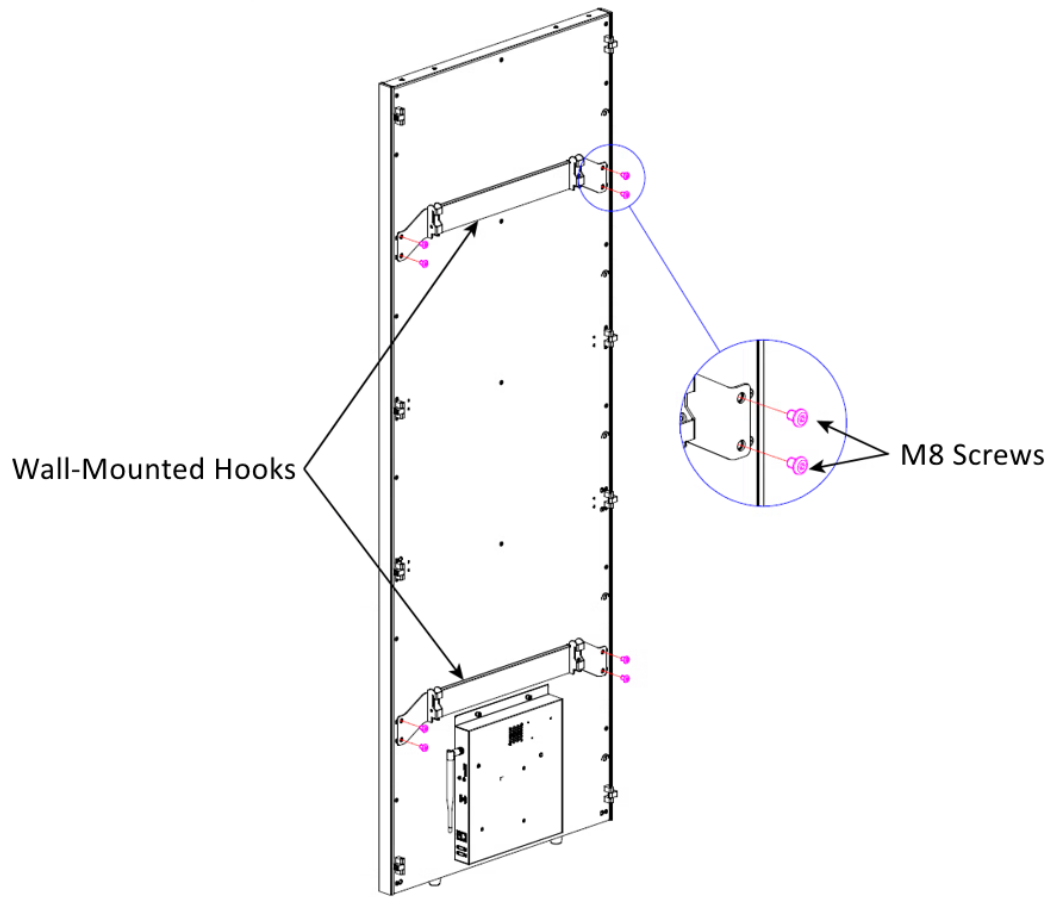

Figure 2-9 Secure Wall-Mounted Hooks

Step 4 Mount the display onto the wall-mounted brackets. Tighten and secure the wall-mounted hooks and wall-mounted brackets using four M4 × 25 screws from both sides of the display to prevent shaking and detachment.

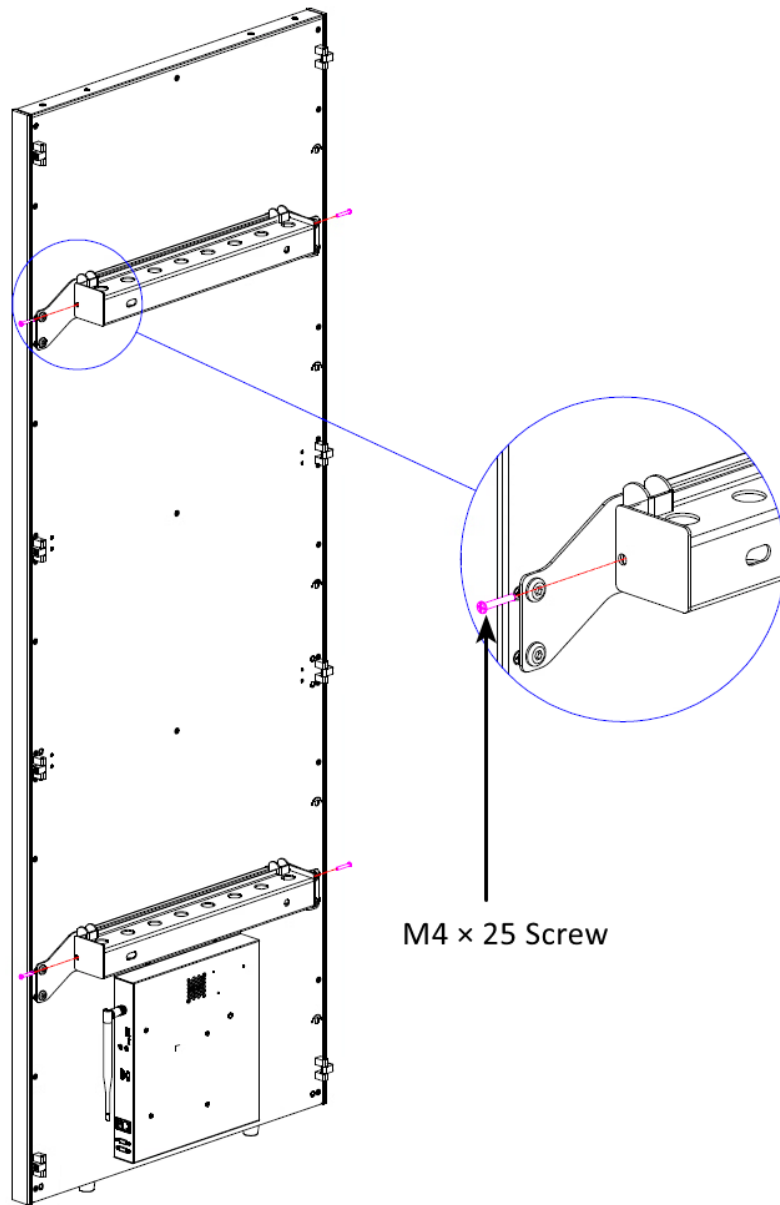

Figure 2-10 Secure Hooks and Brackets

2.5 (Optional) Install Mobile Base for A Single Device

The following steps will give a detailed process of installing the mobile base for a single device taking a **retail** device as an example. For mobile base installation of a single **rental** device, please refer to step 5 to step 10.

Table 2-2 Mobile Base Components

Accessories	Quantity	Accessories	Quantity
Tilt bracket	1	M6 × 16 screw	3
Cabinet extension board	1	Hex wrench	1

Accessories	Quantity	Accessories	Quantity
Mobile base	1	M8 × 16 screw	3
Triangular connecting piece	2	M5 × 8 screw	1
Z-shaped joint piece	4	M4 × 8 screw	10
M6 × 12 screw	10	Open spanner	1

Required main accessories:

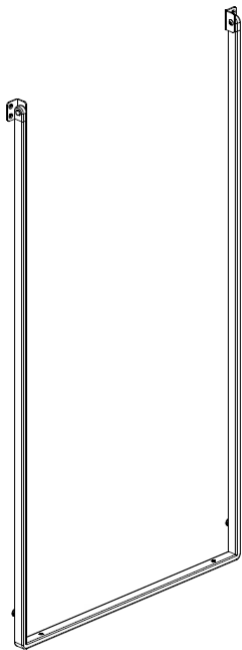

Tilt Bracket

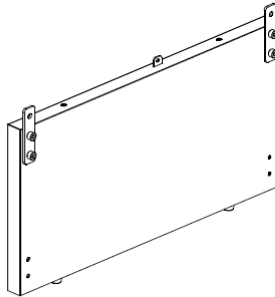

Extension Board

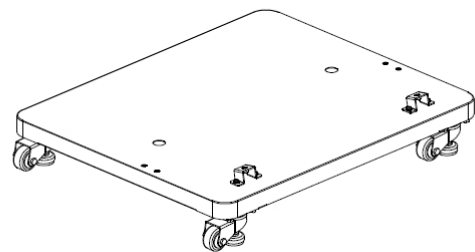

Mobile Base



Triangular Connecting Pieces



Z-shaped Joint Pieces

Figure 2-11 Main Mobile Base Accessories

Step 1 Use a screwdriver to remove the 12 screws on both sides of the tilt bracket and the trim panel at the bottom of the device.

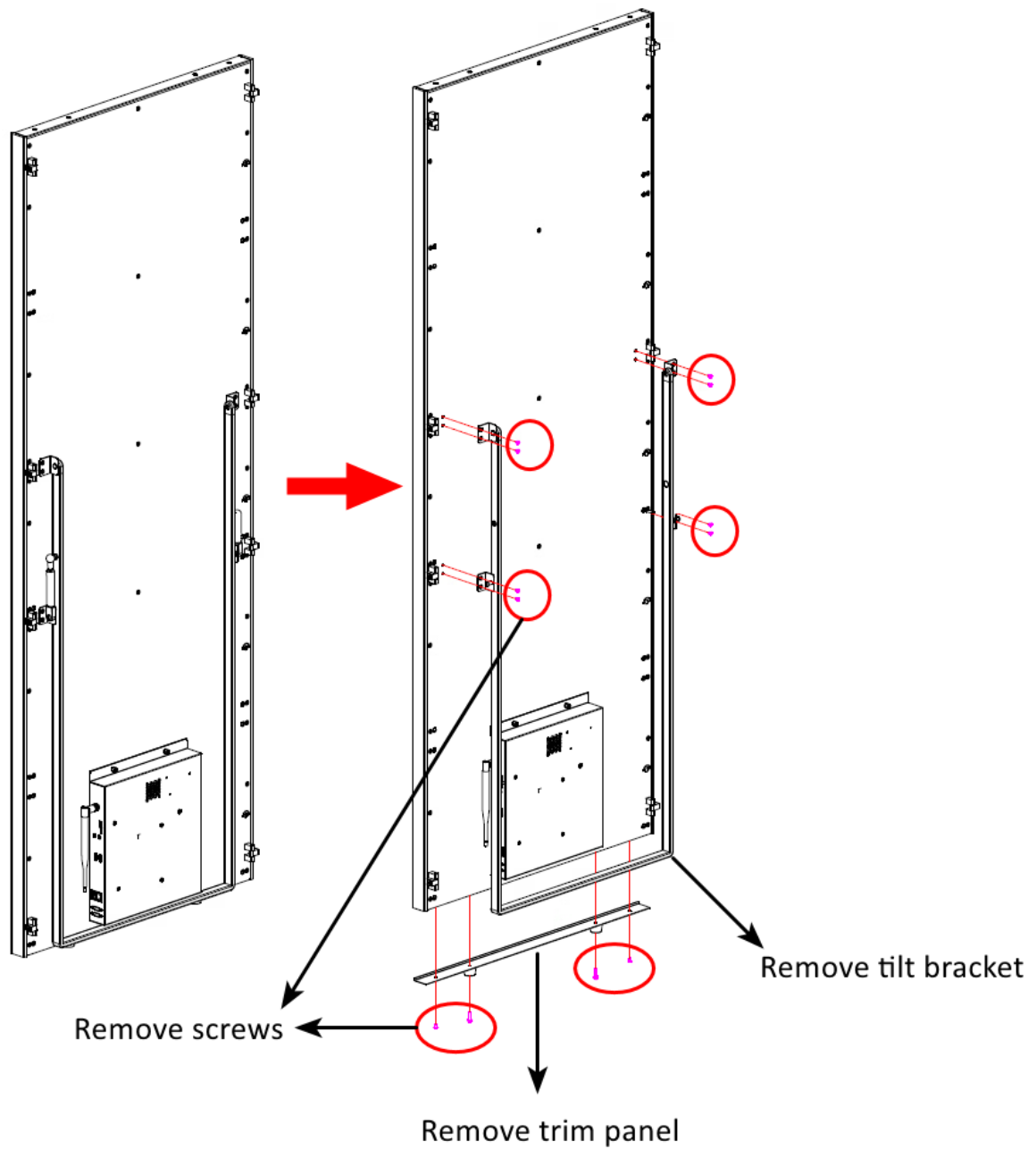
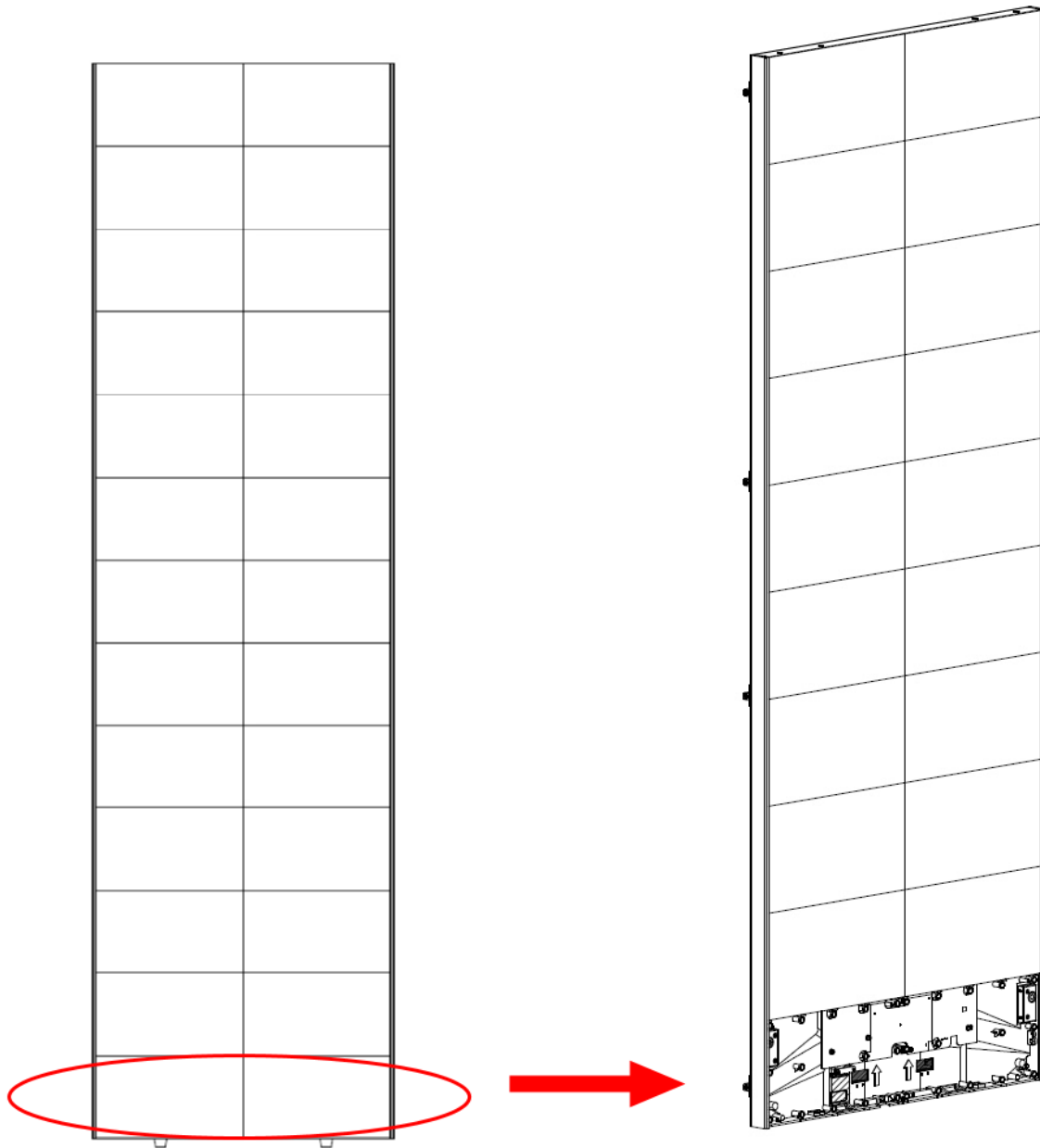

Figure 2-12 Remove Tilt Bracket and Trim Panel

 **Caution**

For subsequent installation, please stow the removed screws after removing the tilt bracket and the trim panel.

Step 2 Remove the two lamp boards in the first row at the bottom of the display from the front side.



Remove the lamp boards in the first row

Figure 2-13 Remove Lamp Boards

Step 3 Install the cabinet extension board at the bottom of the display. Secure the cabinet extension board to the display using two M8 × 16 screws on the rear side and two M6 × 12 screws and one M5 × 8 screw on the front side.

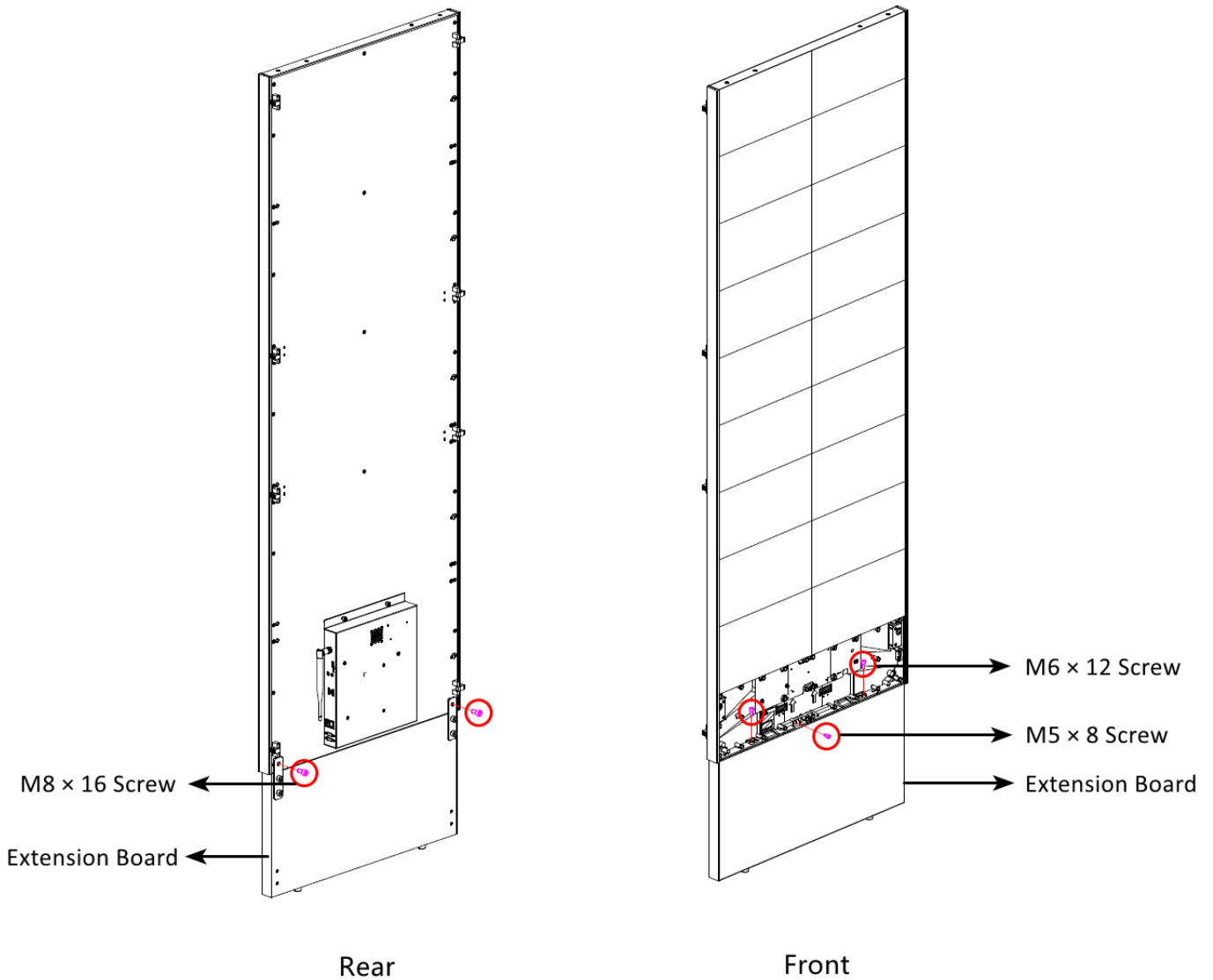

Figure 2-14 Install Cabinet Extension Board

Step 4 Install the new tilt bracket gone with the mobile base to the back of the display using the four screws in Step 1. Reinstall the two lamp boards in the first row at the bottom of the display from the front side.

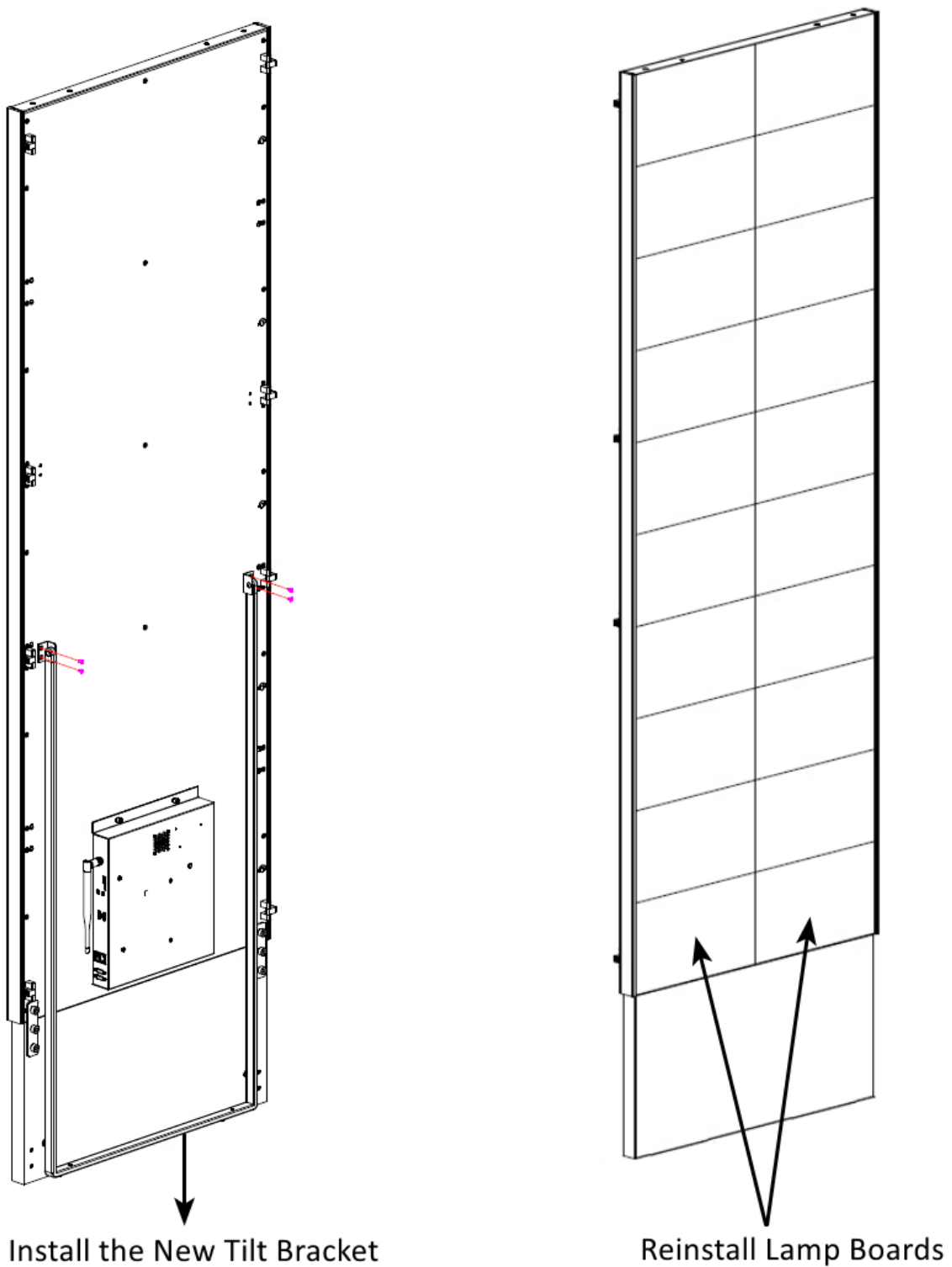

Figure 2-15 Install A New Tilt Bracket and Reinstall Lamp Boards

Step 5 Put the mobile base in place and install four M6 × 65 expansion bolts into the ground according to the installation dimensions of Z-shaped joint pieces illustrated in the following figure.

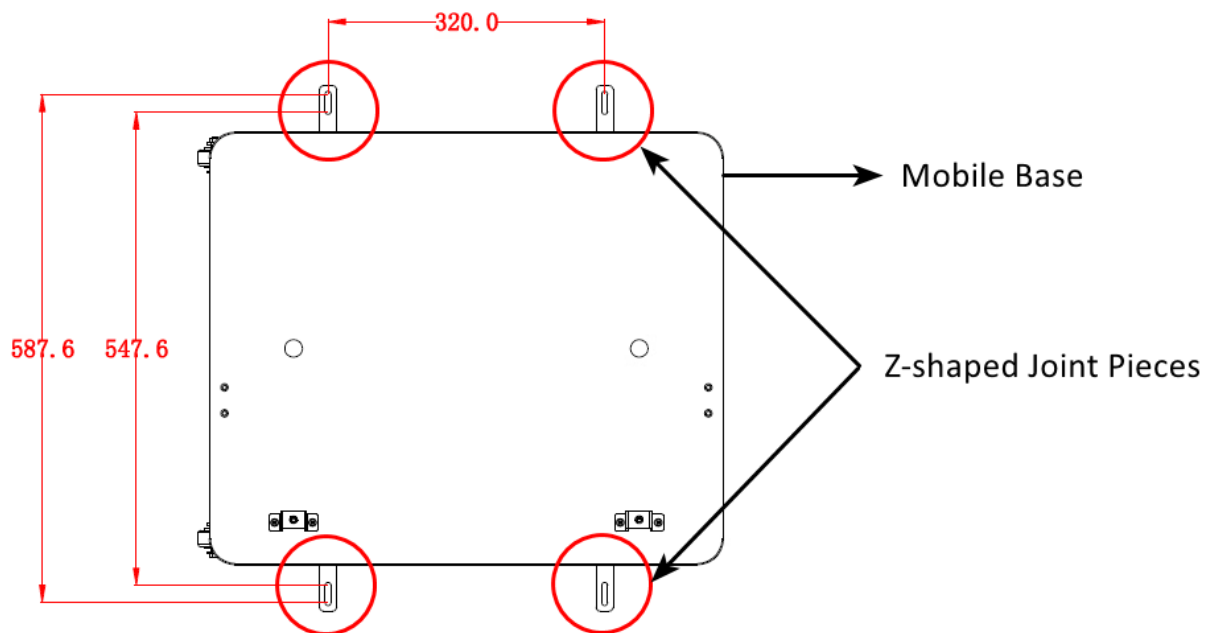

Figure 2-16 Installation Dimension Requirements

 **Caution**

- The device cannot be moved after installing the Z-shaped joint pieces. Install the joint pieces as required.
- If the Z-shaped joint pieces are not installed, do not put the mobile base on a slope exceeding 12°.
- Avoid pushing the mobile base forcefully.

Step 6 Use four M4 × 8 screws to install the four Z-shaped joint pieces at the bottom of the mobile base.

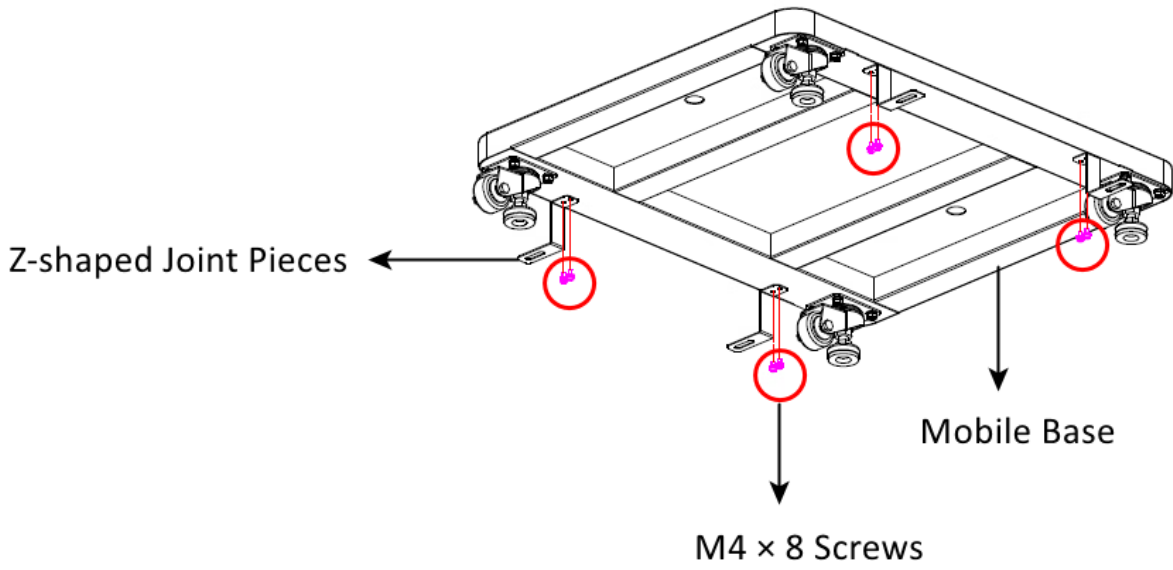

Figure 2-17 Install Z-shaped Joint Pieces

Step 7 Secure the mobile base to the floor using four M6 × 65 expansion bolts.

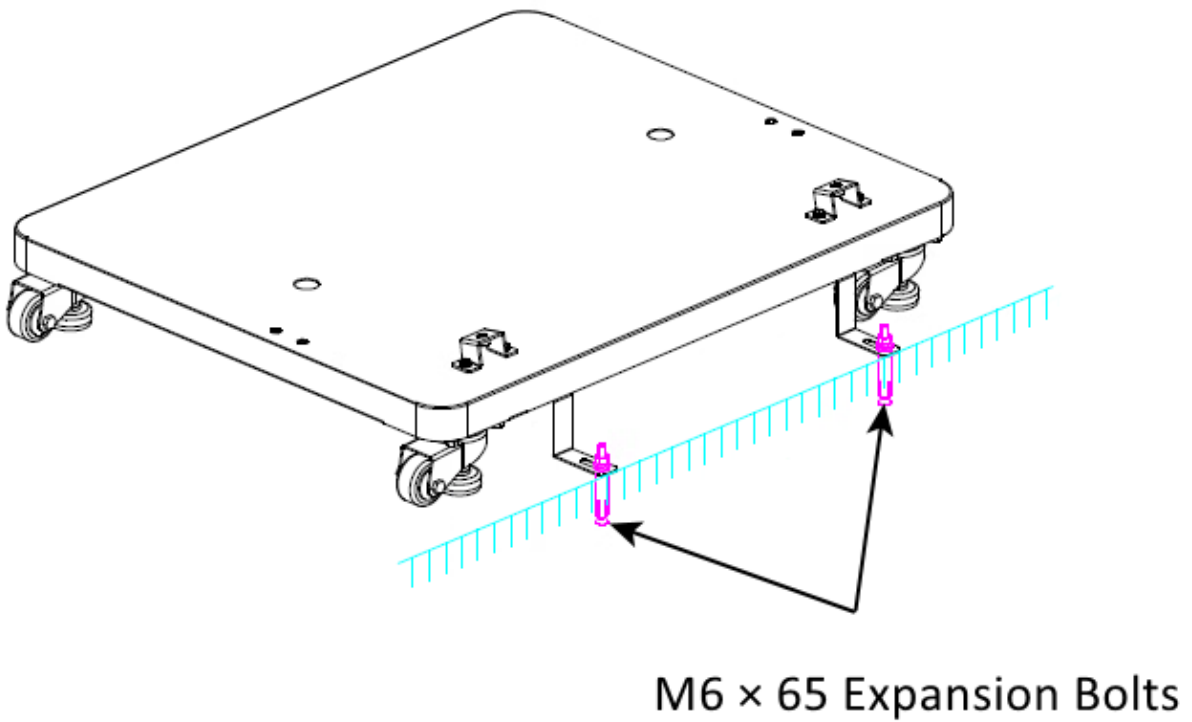

Figure 2-18 Secure Mobile Base

Step 8 Align the foot pads at the bottom of the display with the locating holes on the mobile base and put the display vertically in place.

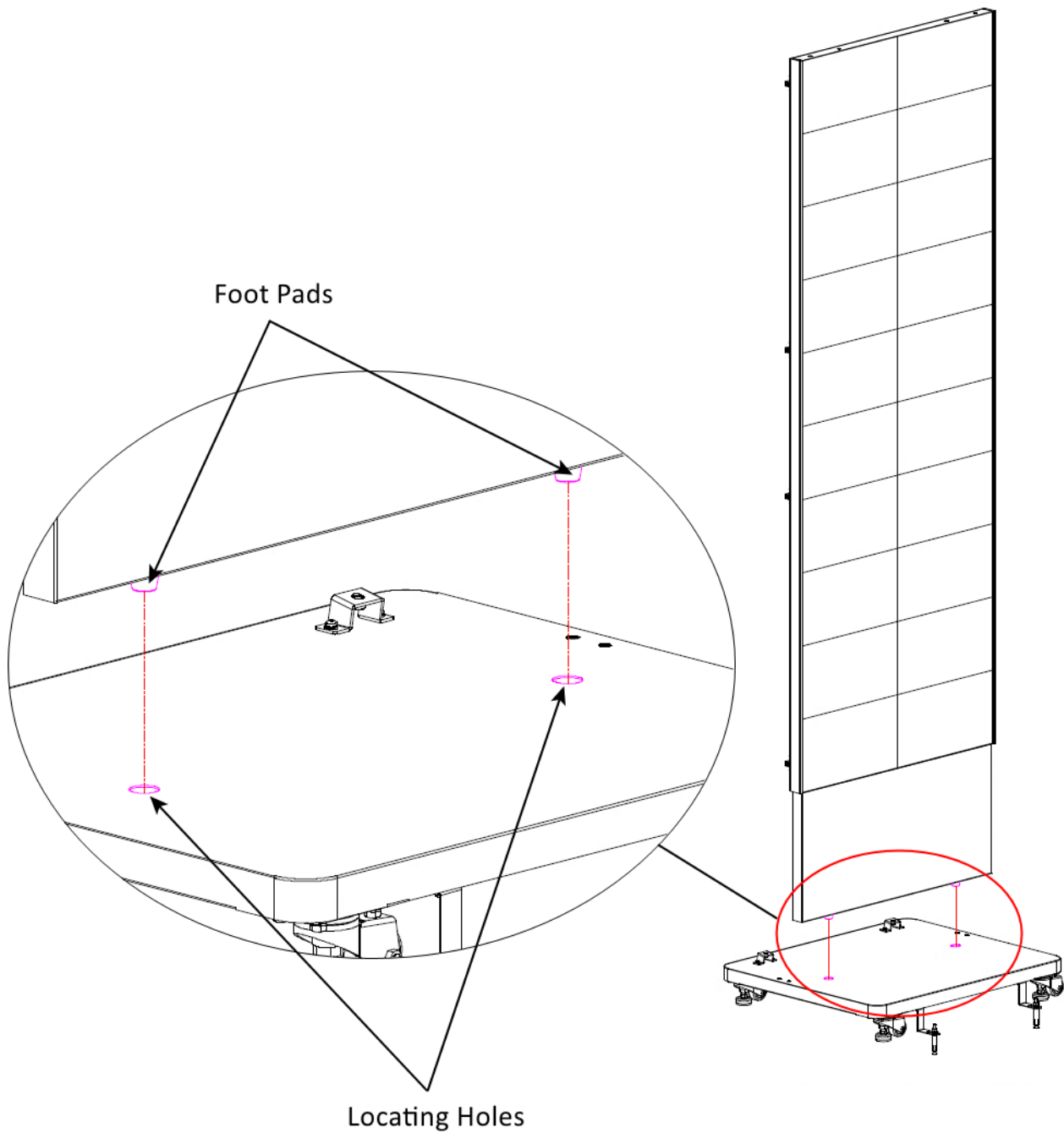

Figure 2-19 Align Foot Pads with Locating Holes

 **Caution**

When installing and removing the display, at least one person should hold the display steady to prevent personal injury and device damage caused by the display tipping over.

Step 9 Open the tilt bracket on the back of the display and secure it to the mobile base using two M6 × 16 screws.

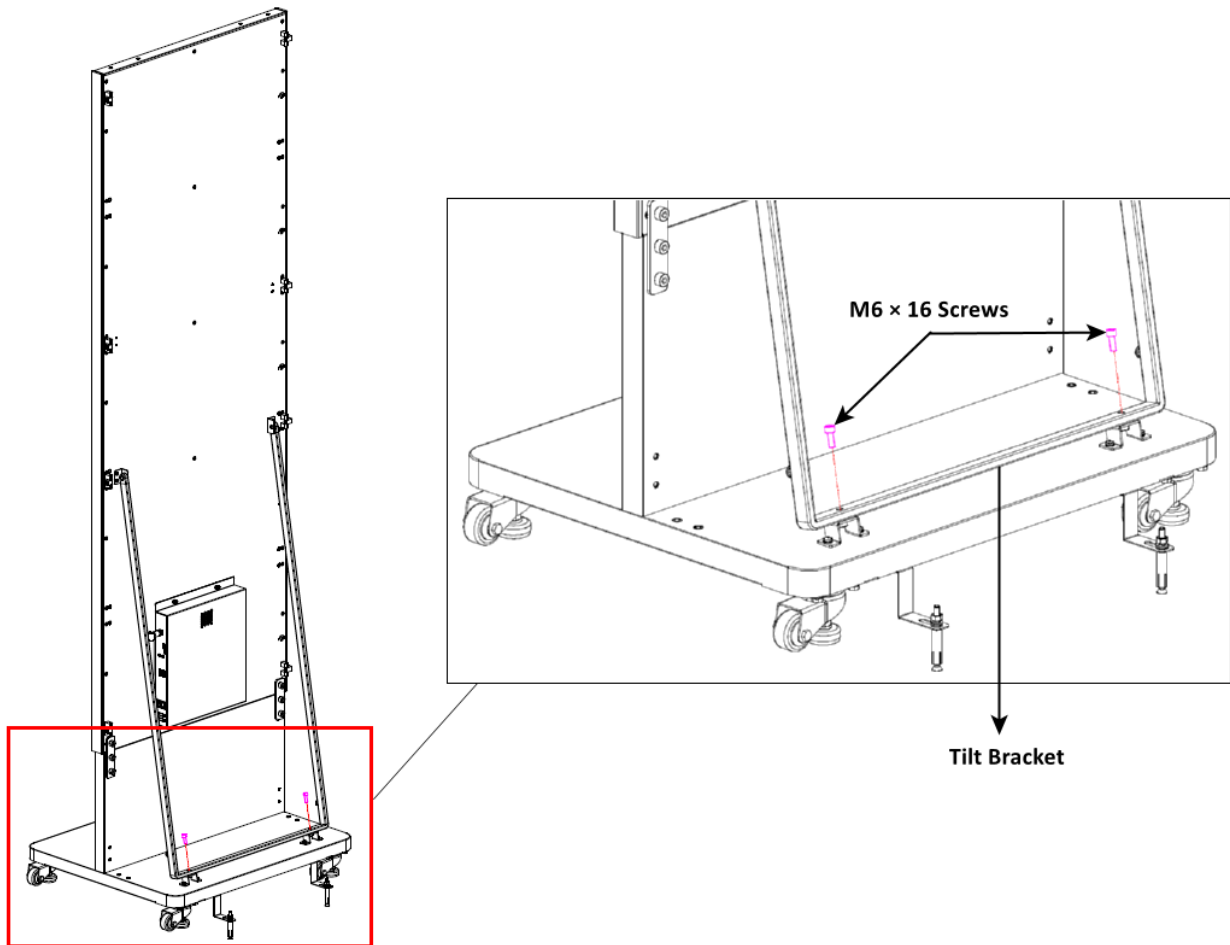

Figure 2-20 Secure Tilt Bracket to Mobile Base

Step 10 Place two triangular connector pieces on both sides at the bottom of the rear panel of the display. Use eight M6 × 12 screws to fasten the connector pieces, display, and mobile base together.

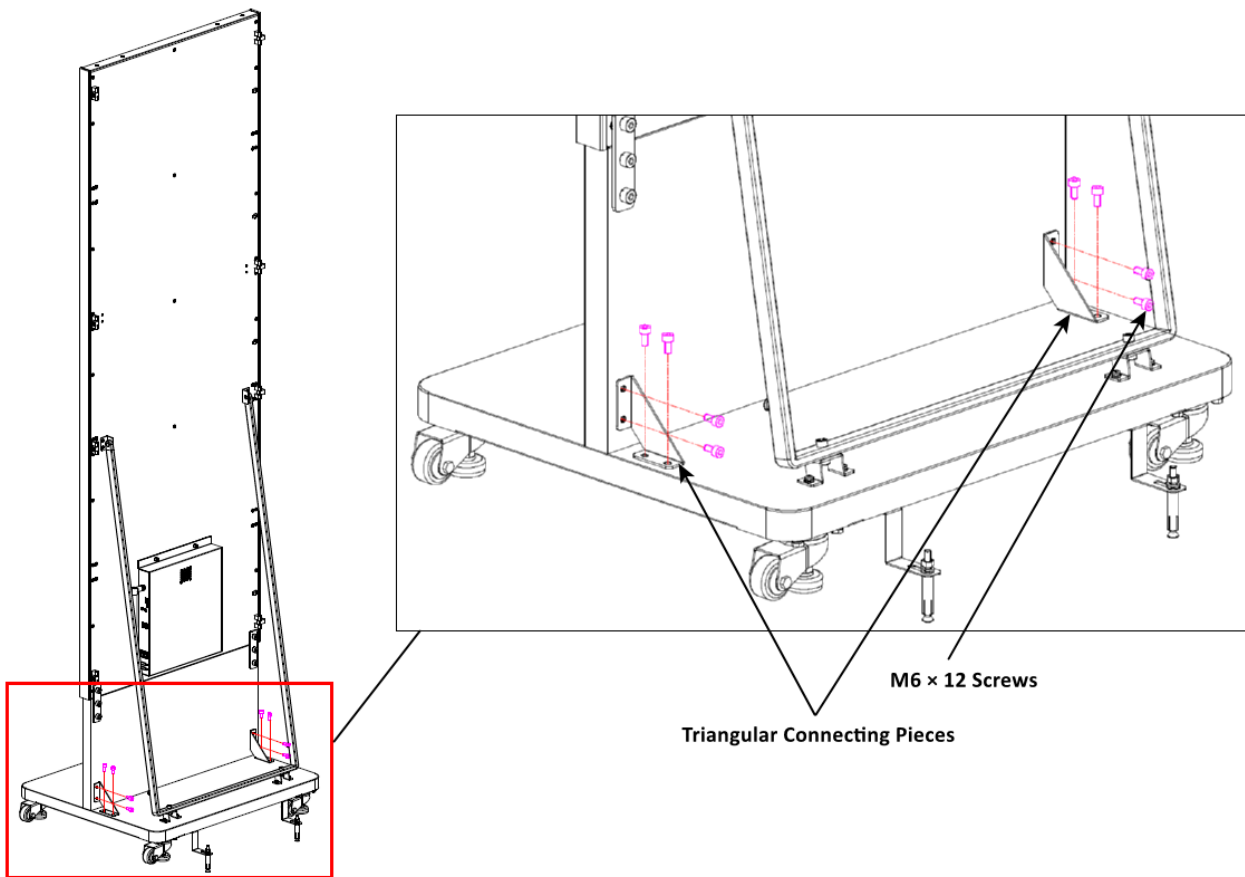

Figure 2-21 Fasten Display and Mobile Base

Step 11 Use an open spanner to turn the four foot pads clockwise at the bottom of the mobile base, grounding them to fix the base onto the floor.

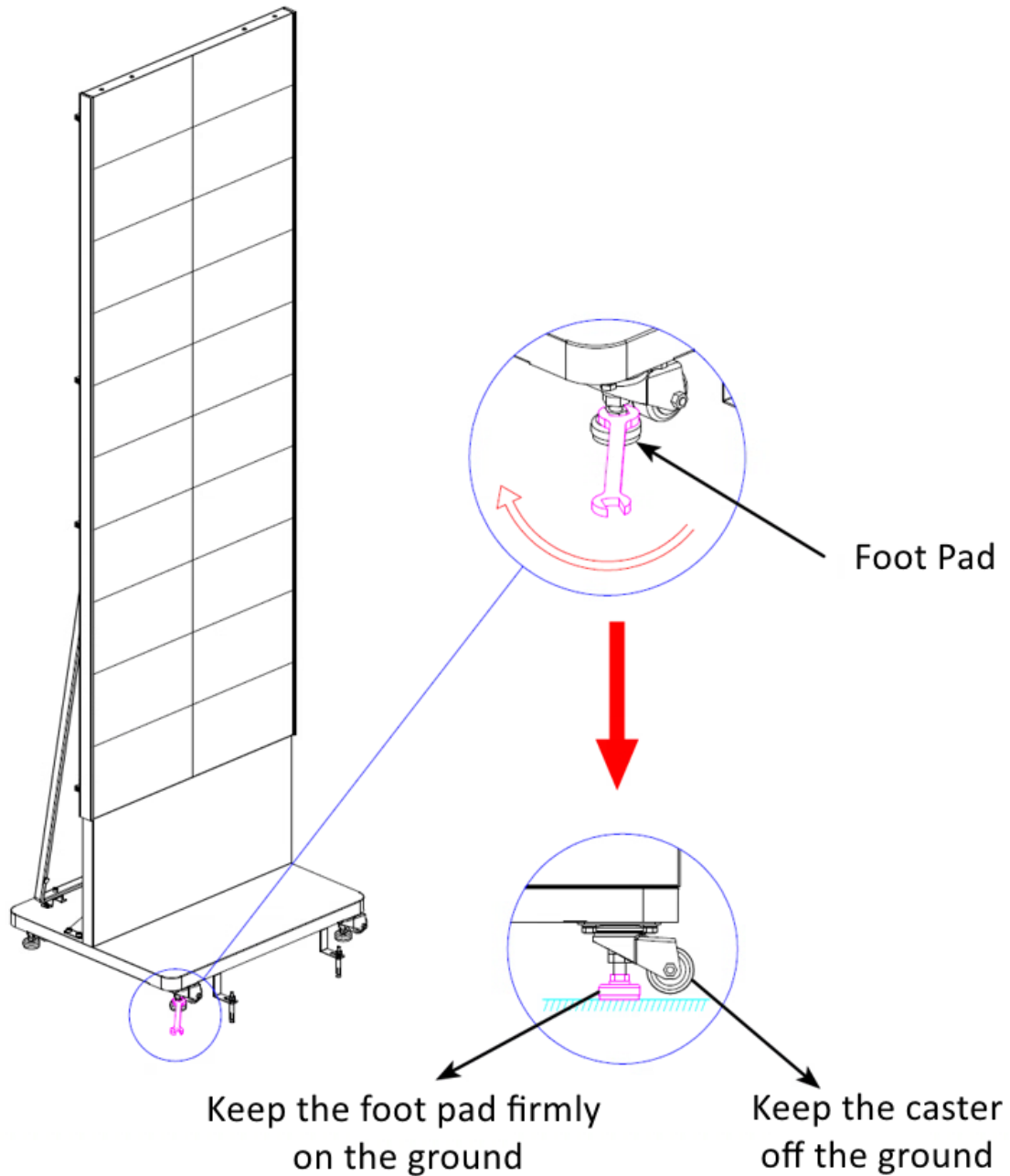

Figure 2-22 Fix Foot Pads onto the Floor

 **Caution**

- The foot pads can be extended up to 10 mm. It is recommended to adjust them until the casters are 5 mm above the floor.
- If the mobile base is uneven or the display height adjustment is needed, extent the height of the foot pads accordingly.
- Whether the Z-shaped joint pieces are installed or not, keep the foot pads firmly on the ground after confirming the location of device to prevent device movement.

Step 12 (Optional) Turn the foot pads counterclockwise with an open spanner to keep them off the ground, which allows the casters to contact the floor for device movement.

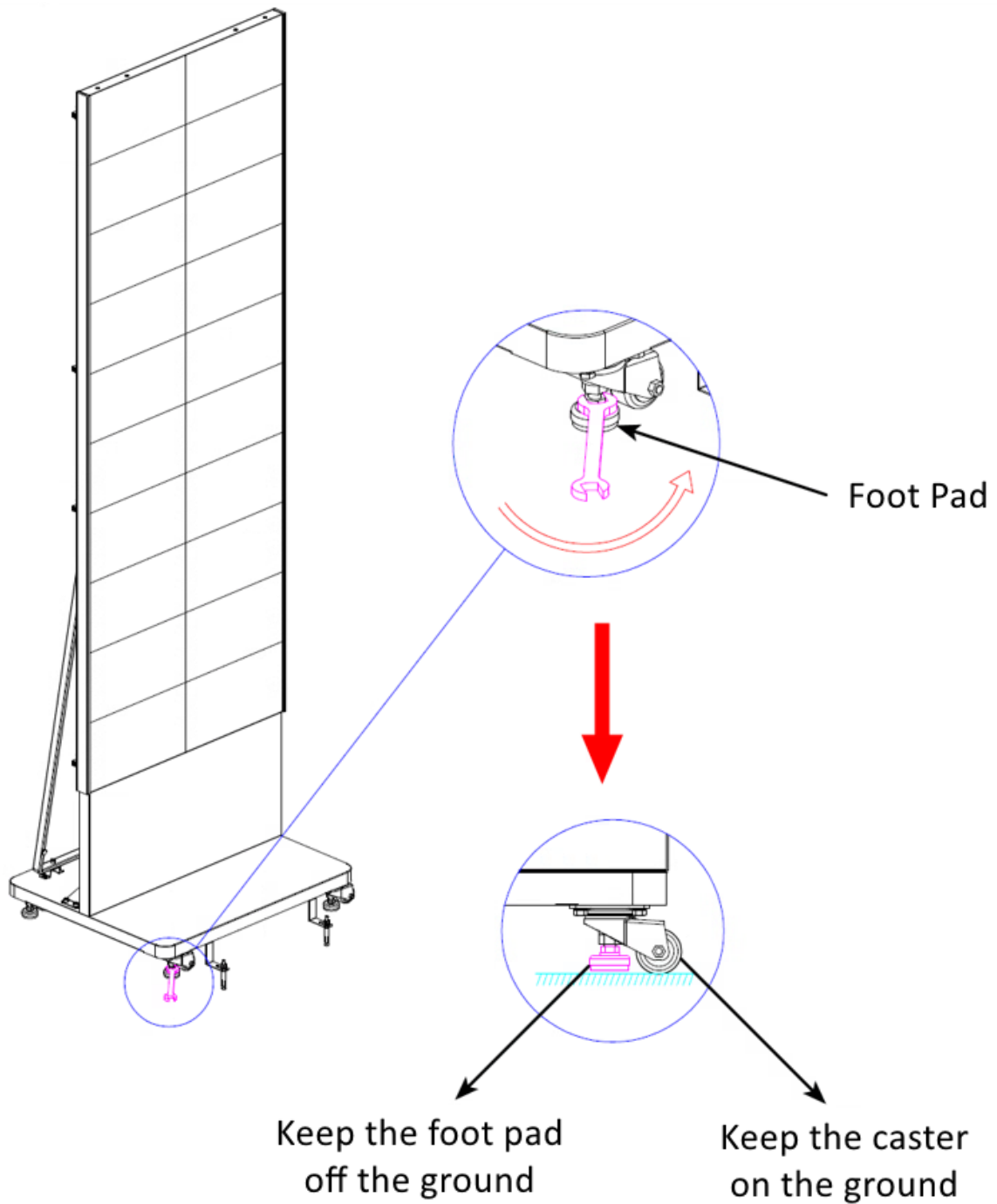

Figure 2-23 Keep Foot Pads off the Ground

2.6 Splice Multiple Devices

2.6.1 Standard Splicing for Multiple Devices

For standard splicing of retail devices, install the devices according to the steps below.

Step 1 Open the bezels on the splicing side of the display according to the arrow direction and rotate them to the maximum degree, as shown in the figure below.

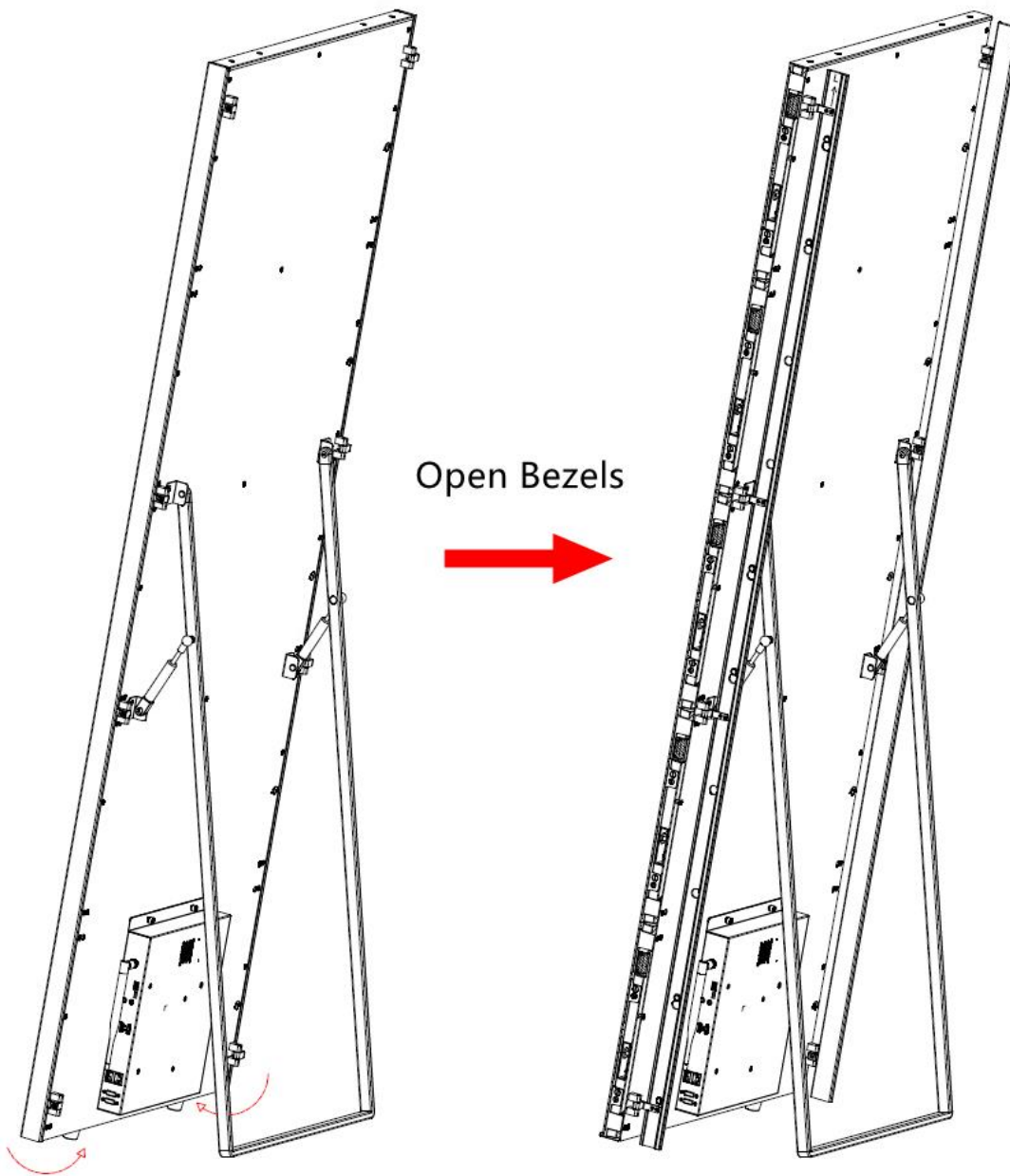

Figure 2-24 Open Bezels

Step 2 Align the locating stud on the side of one display with the locating hole on the adjacent display, then splice the two displays together.

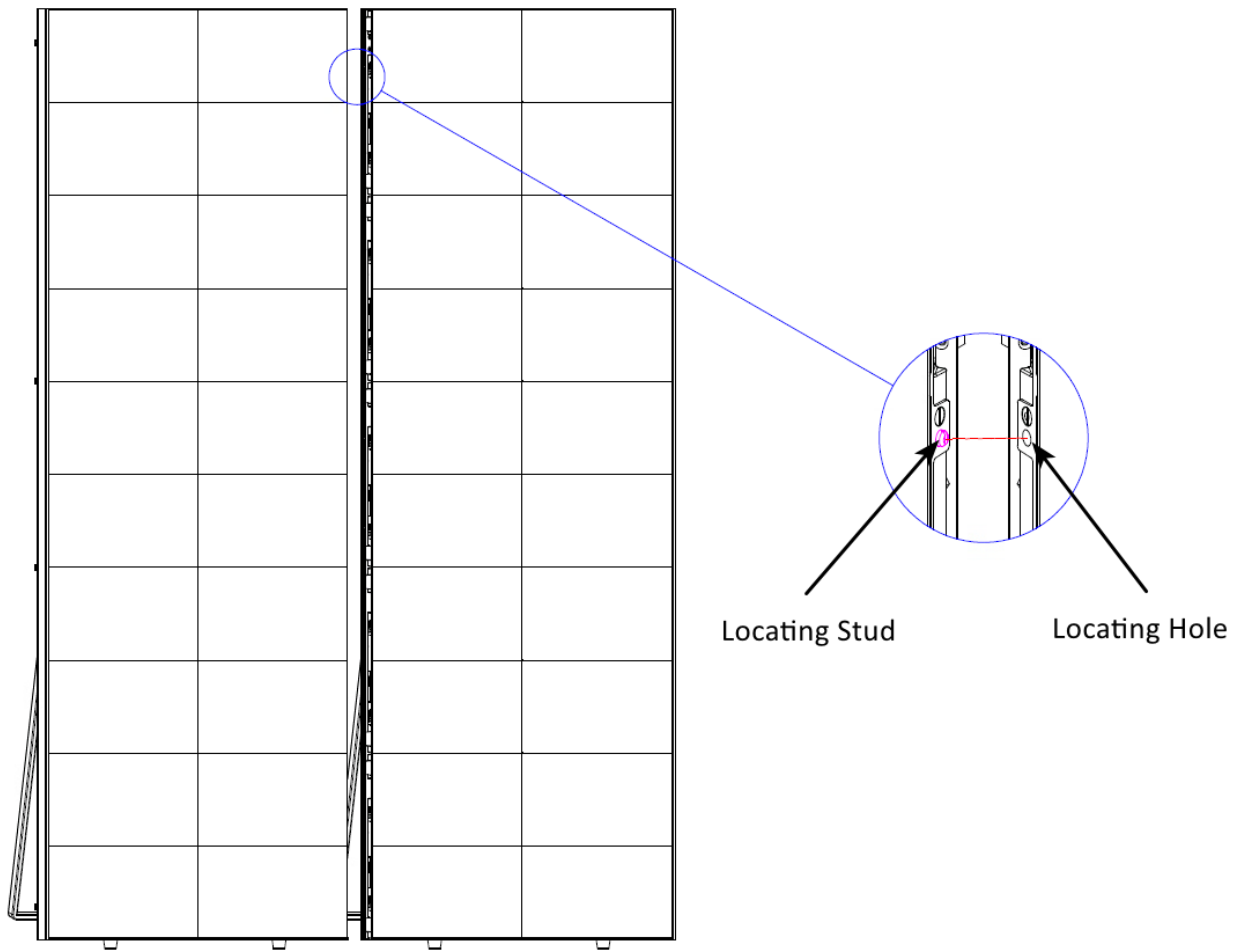

Figure 2-25 Align Locating Stud with Locating Hole

Step 3 Insert the hex wrench into the locking holes on the back of the display. Turn the hex wrench clockwise to the maximum degree, then rotate it counterclockwise to lock the two displays. Repeat this step to secure all five holes sequentially.

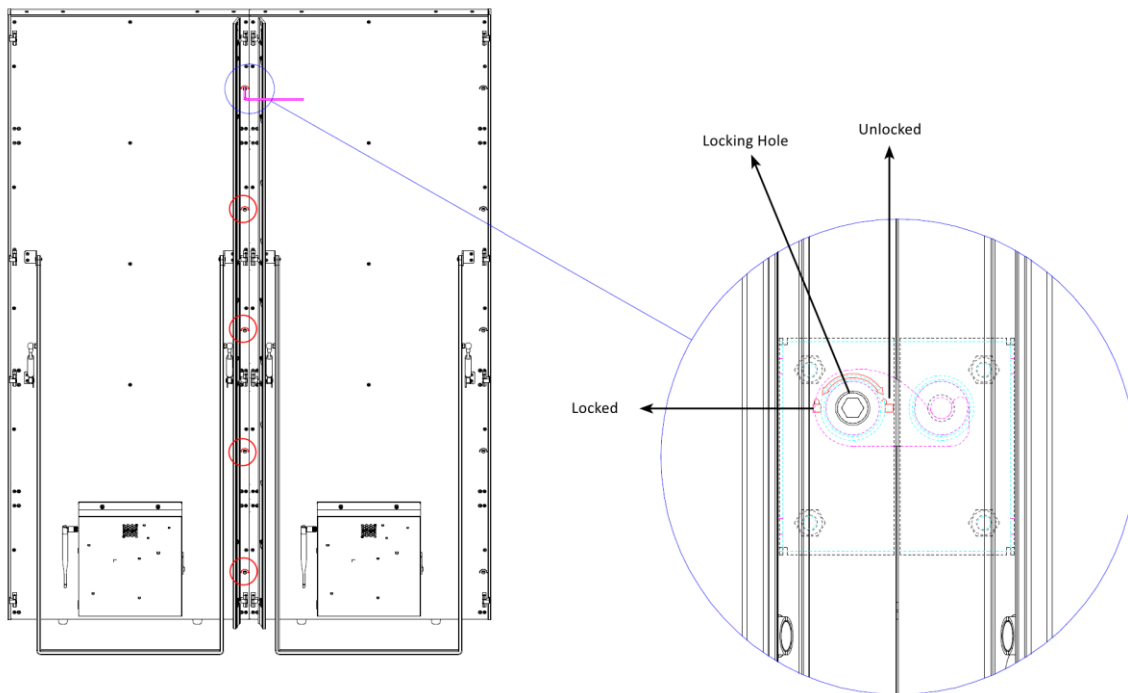

Figure 2-26 Lock Adjacent Displays

Caution

Ensure that the hex wrench can be rotated smoothly after inserting it into the locking holes. Do not insert it forcefully or too deeply to avoid damaging the lamp boards.

2.6.2 Wall-Mounted Splicing for Multiple Devices

Splice Multiple Retail Devices

For wall-mounted splicing of retail devices, follow the steps below.

Step 1 Install the wall-mounted brackets on the wall according to the dimensions shown in the figure below.

Step 2 Remove the tilt brackets on the back of the displays to be spliced.

Step 3 Open the bezels on the splicing side of the displays, then refer to step 3 in **2.4 (Optional) Install Wall-Mounted Bracket for A Single Device** to secure the wall-mounted hooks.

Step 4 Remove the corresponding lamp boards near the locking holes, insert and rotate the hex wrench from the front side to lock the adjacent displays. The locking direction is opposite to that when locking the displays from the rear side.

Step 5 Refer to step 4 in **2.4 (Optional) Install Wall-Mounted Bracket for A Single Device** to secure the wall-mounted brackets.

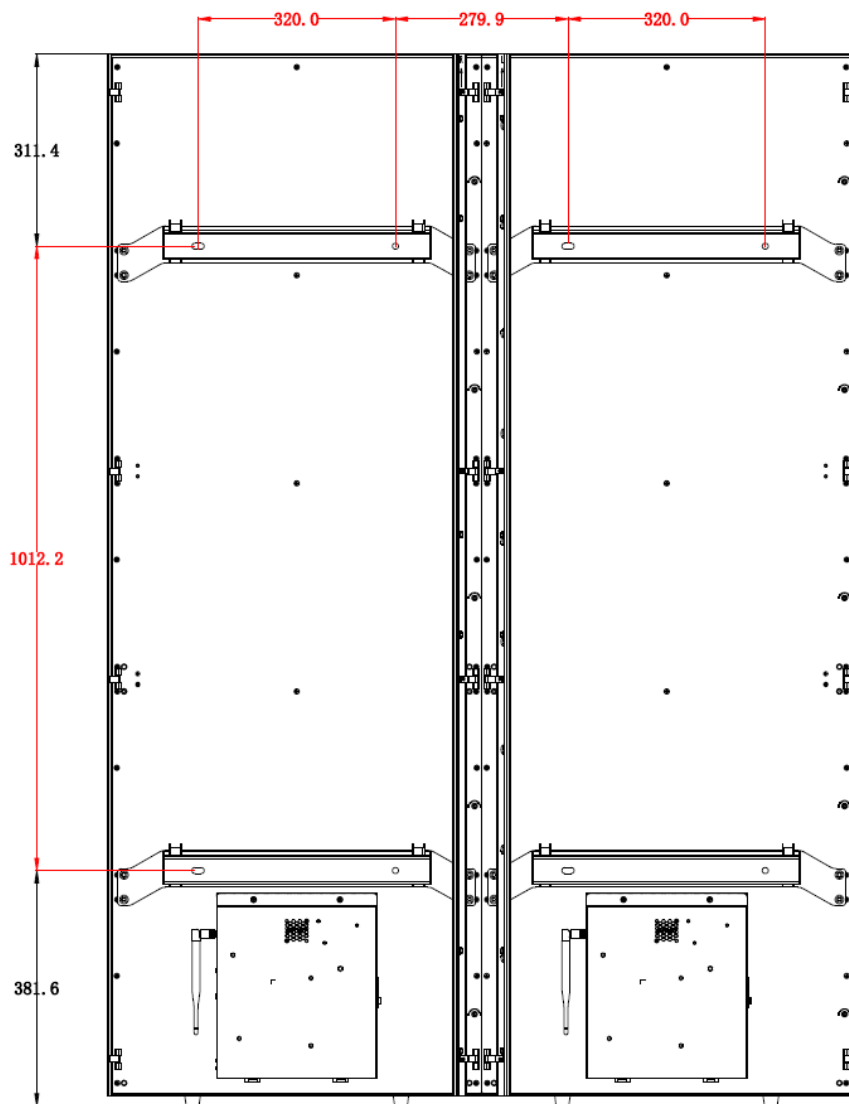

Figure 2-27 Installation Dimensions Requirement

! Caution

Use at least two M4 × 25 screws to secure the wall-mounted hooks and brackets on the rear side for each display.

Splice Multiple Rental Devices

For wall-mounted splicing of rental devices, follow the steps below.

Step 1 Remove the four screws and tilt bracket on the back of the display.

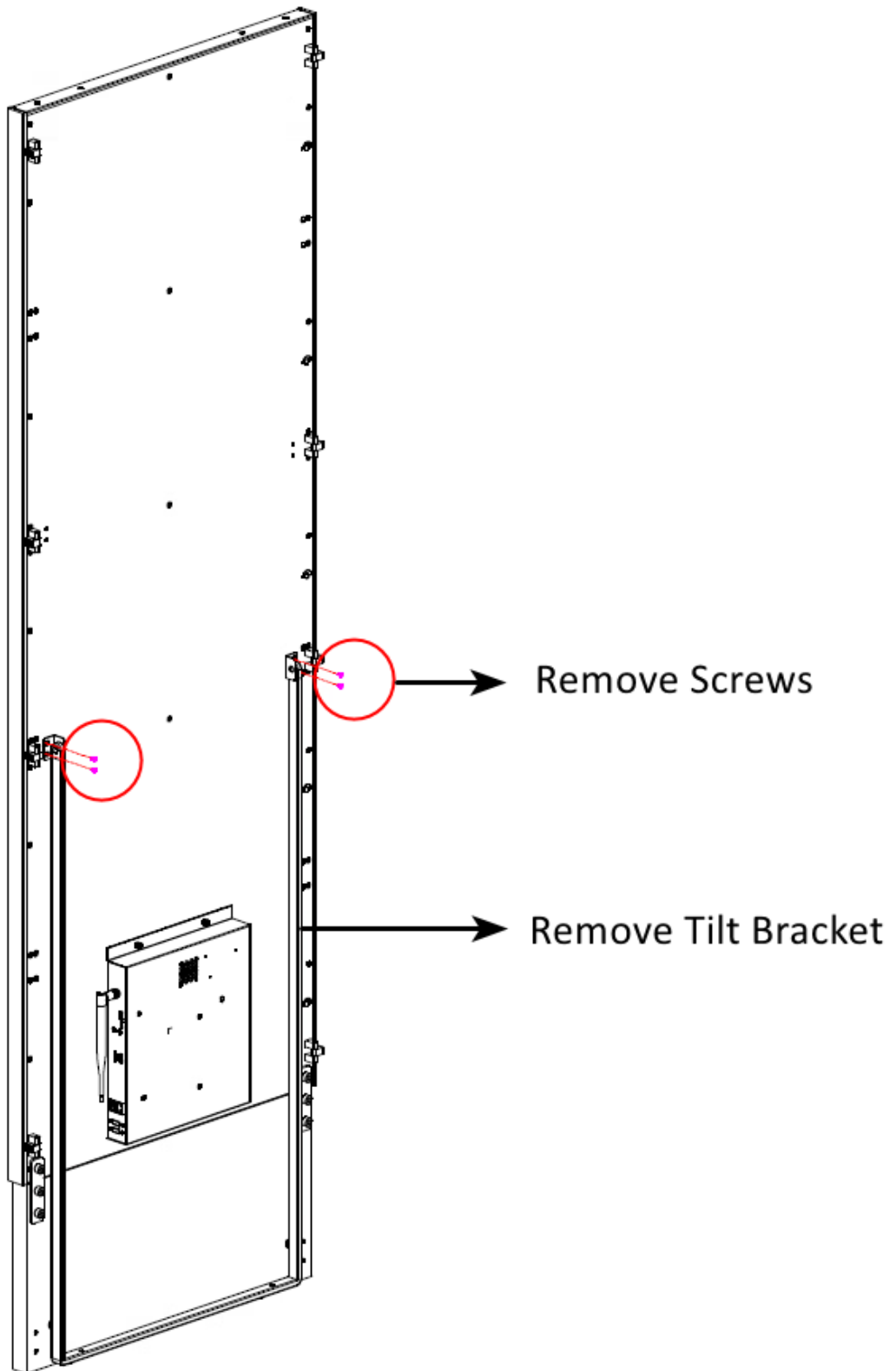

Figure 2-28 Remove Tilt Bracket

Step 2 Remove the two lamp boards in the first row at the bottom front of the display. Remove the two M6 × 12 screws and one M5 × 8 screw on the extension board from the front side, and the two M8 × 16 screws from the rear side, then detach the extension board.

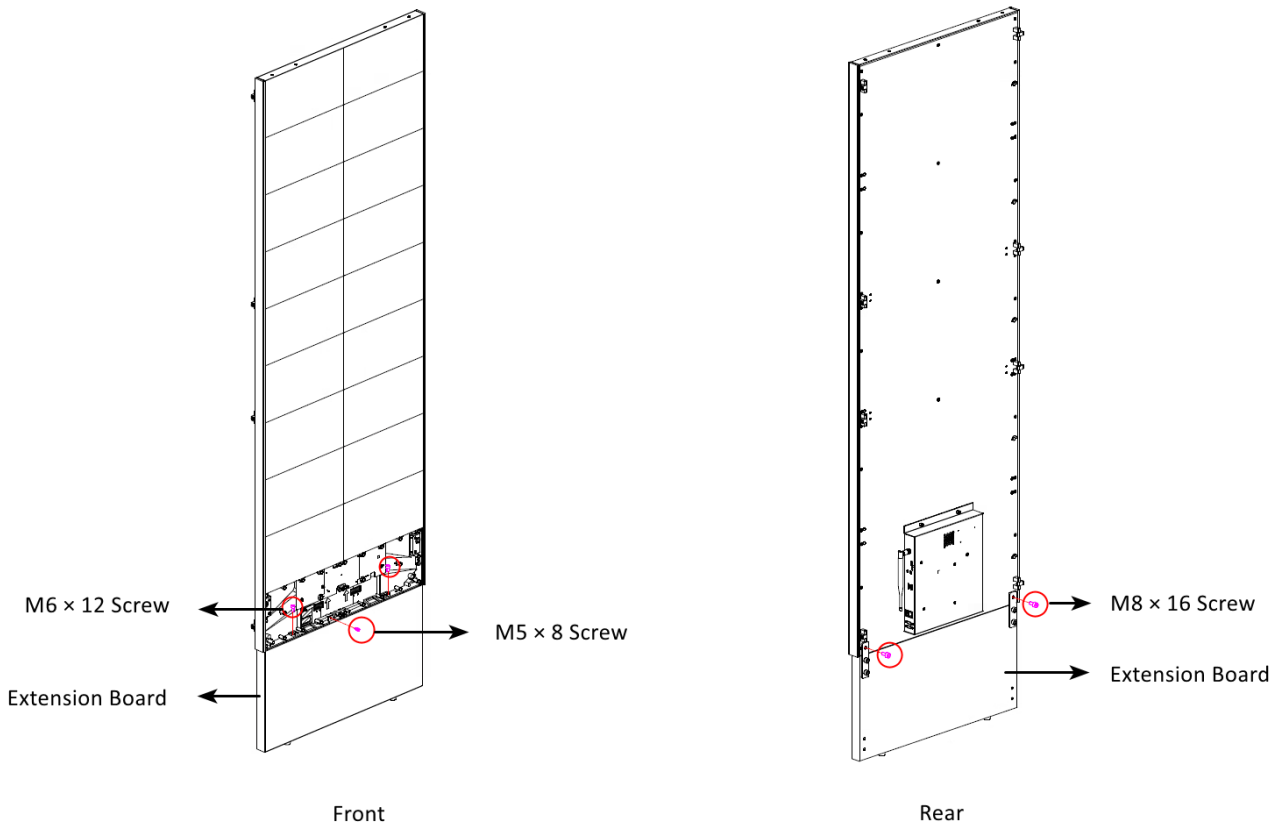

Figure 2-29 Remove Extension Board and Screws

Step 3 Refer to the steps of wall-mounted splicing for multiple retail devices to complete the wall-mounted splicing for multiple rental devices, see **2.6.2 Wall-Mounted Splicing for Multiple Devices**.

2.6.3 Mobile Base Splicing for Multiple Devices

Step 1 Refer to step 8 to step 10 in **2.5 (Optional) Install Mobile Base for A Single Device** to secure the display to the mobile base.

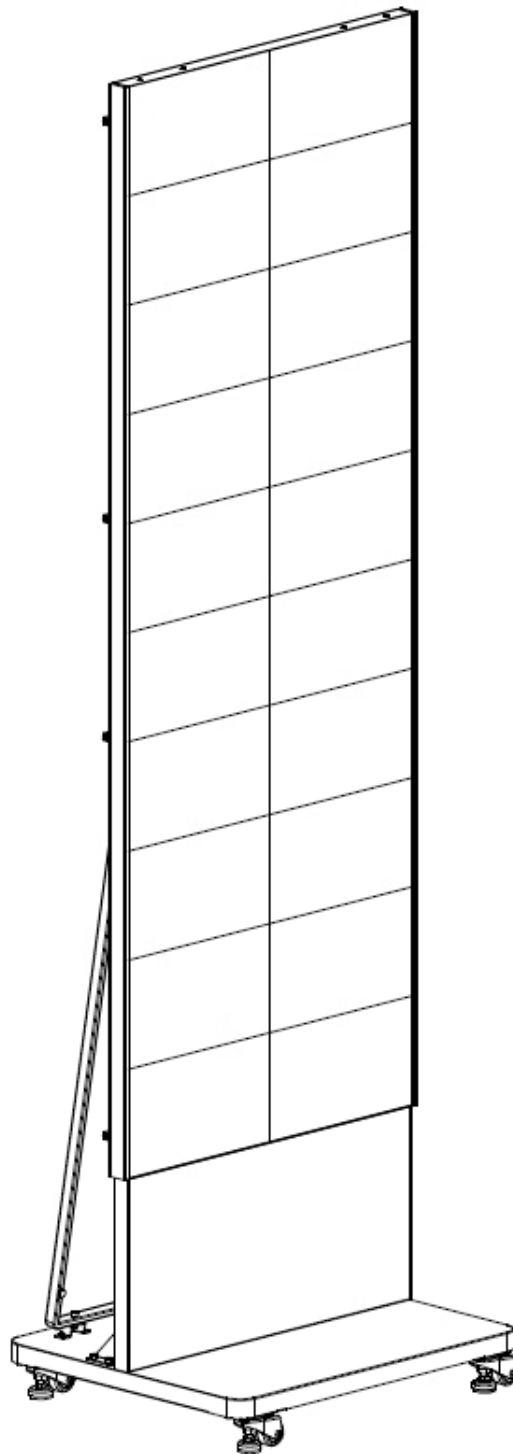

Figure 2-30 Secure Display to Mobile Base

 **Caution**

- The device cannot be moved after installing the Z-shaped joint pieces. Install the joint pieces as required.
-

- If the Z-shaped joint pieces are not installed, do not put the mobile base on a slope exceeding 12°.
- Avoid pushing the display forcefully.

Step 2 Open the bezels on the splicing side of the displays according to the arrow direction and rotate them to the maximum degree, splice the adjacent displays, and lock them in place.

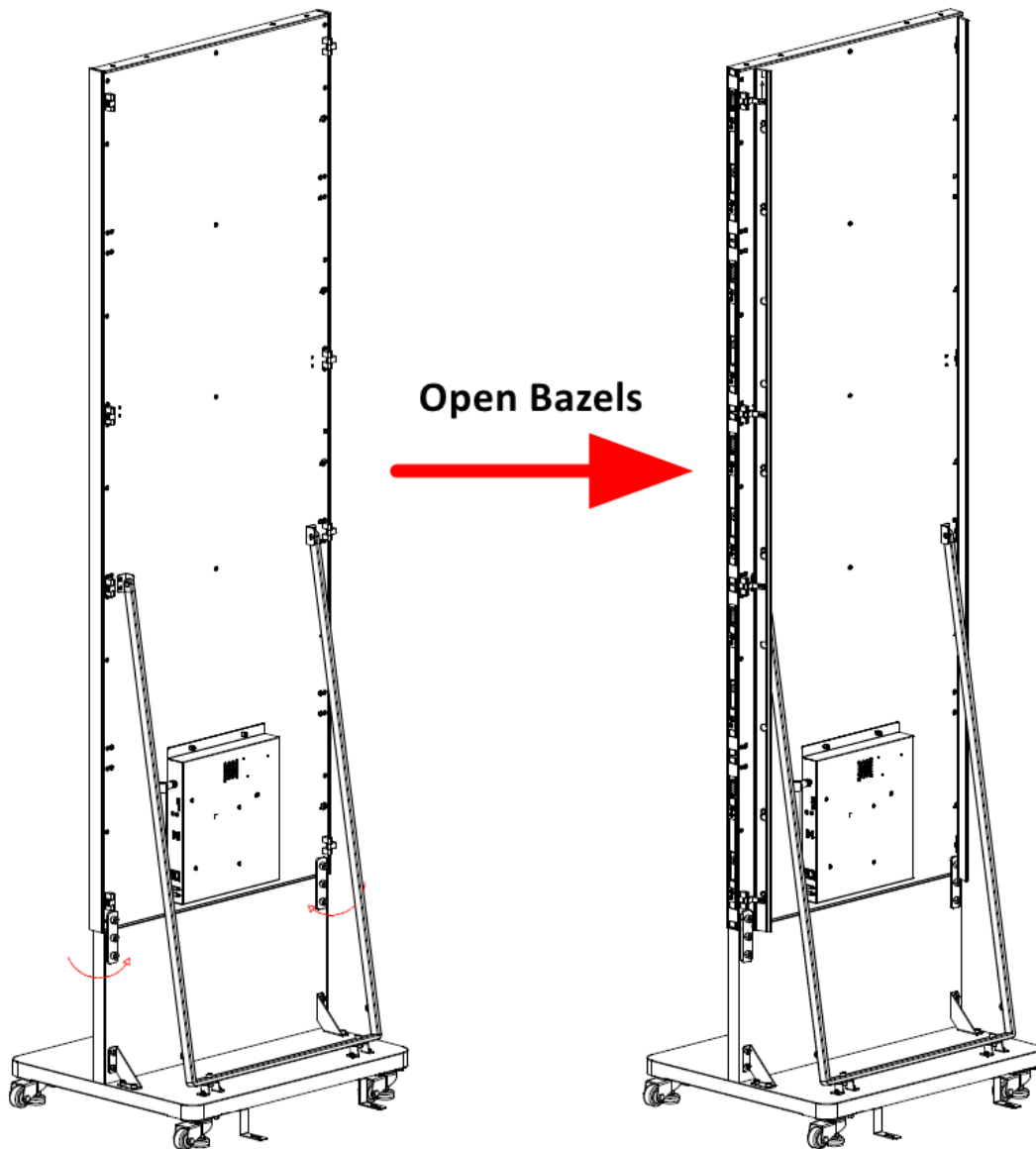

Figure 2-31 Open Bezels

 **Note**

Retail devices do not include extension boards, which must be installed before mobile base splicing.

Step 3 Align the locating stud on the side of one display with the locating hole on the adjacent display, then splice the two displays together.

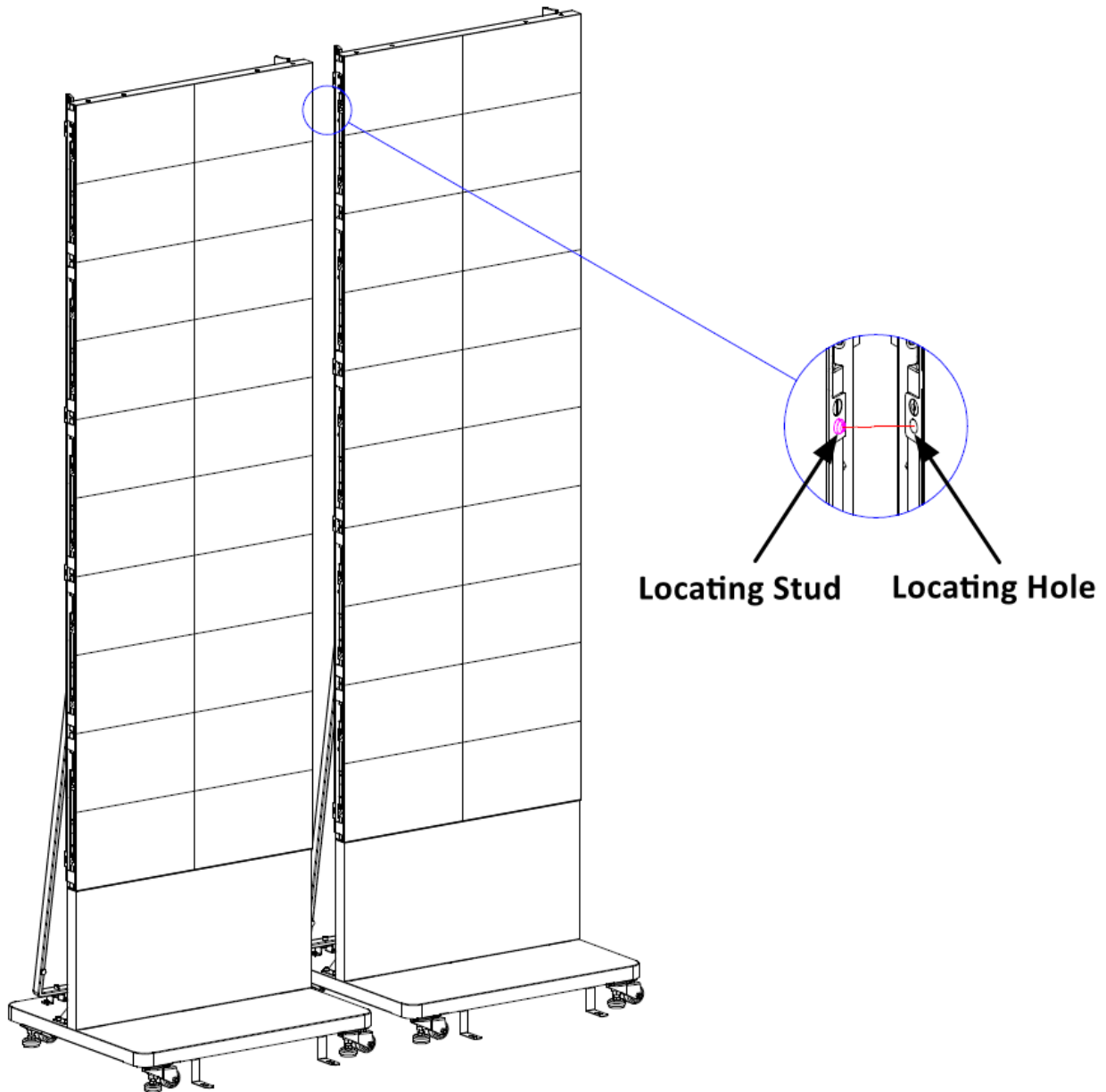

Figure 2-32 Align Locating Stud with Locating Hole

Step 4 Insert the hex wrench into the locking holes on the back of the display. Turn the hex wrench clockwise to the maximum degree, then rotate it counterclockwise to lock the two displays. Repeat this step to secure all five holes sequentially.

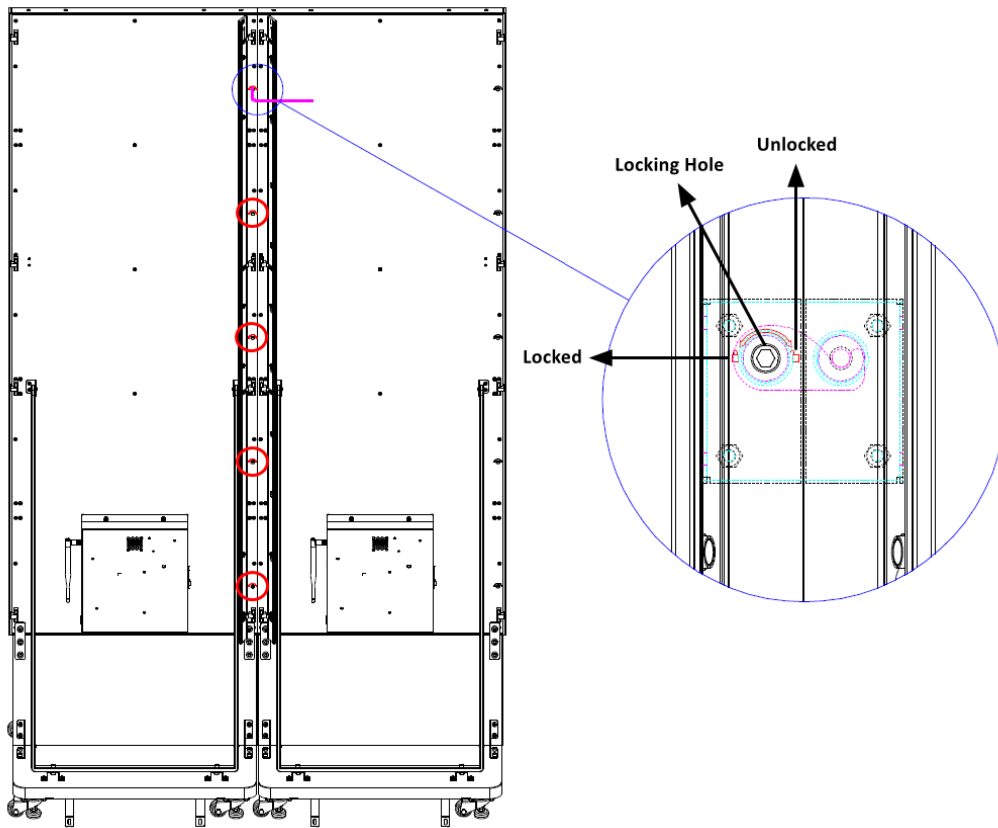

Figure 2-33 Lock Adjacent Displays

Step 5 Repeat the above steps to complete the mobile base splicing for the remaining devices.

Step 6 After splicing all devices, to ensure the stability of the display, please use foundation bolts to lock the Z-shaped joint pieces. You can find the installation dimensions below.

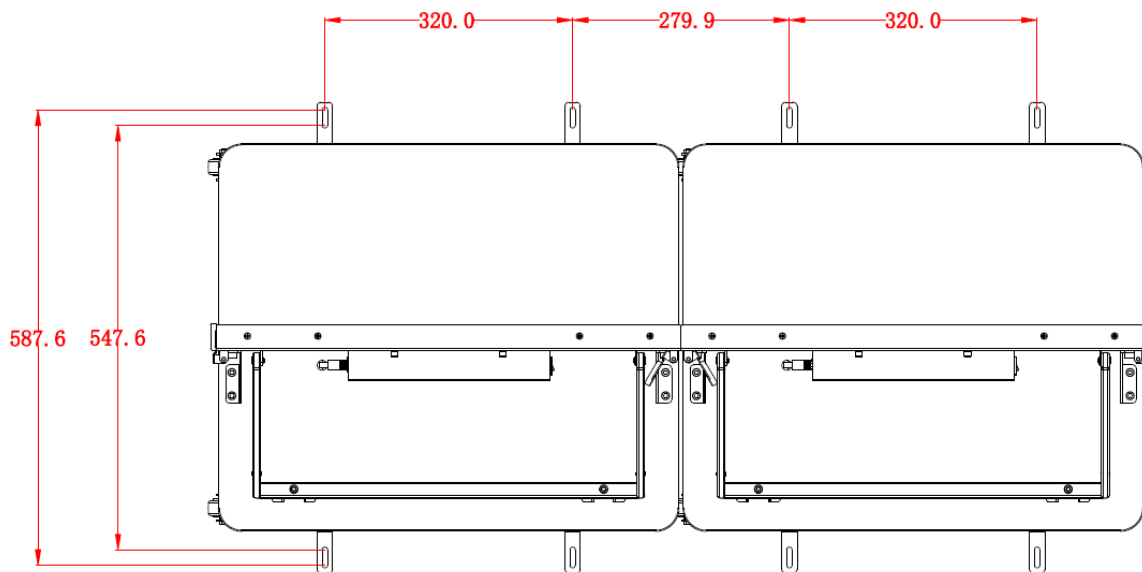

Figure 2-34 Installation Dimensions

Caution

- The device cannot be moved after installing the Z-shaped joint pieces. Install the joint pieces as required.
- If the Z-shaped joint pieces are not installed, do not put the mobile base on a slope exceeding 12°.
- Avoid pushing the display forcefully.

2.7 Device Wiring

After the device is installed, connect the power cord and signal cable as required.

All interfaces that can be found on the rear panel of the device are defined as follows.

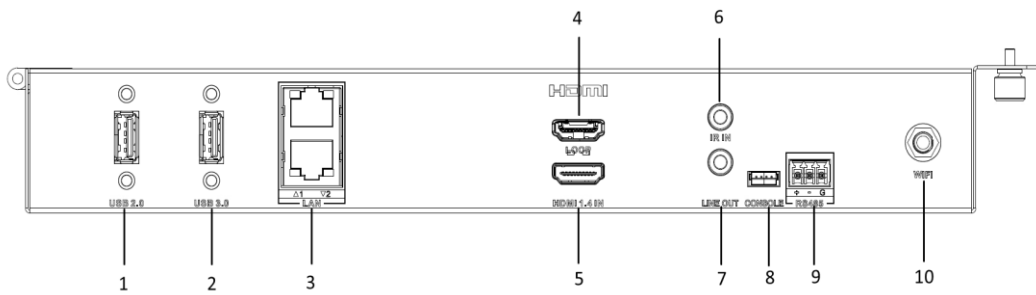

Figure 2-35 Interfaces on the Rear Panel (1)

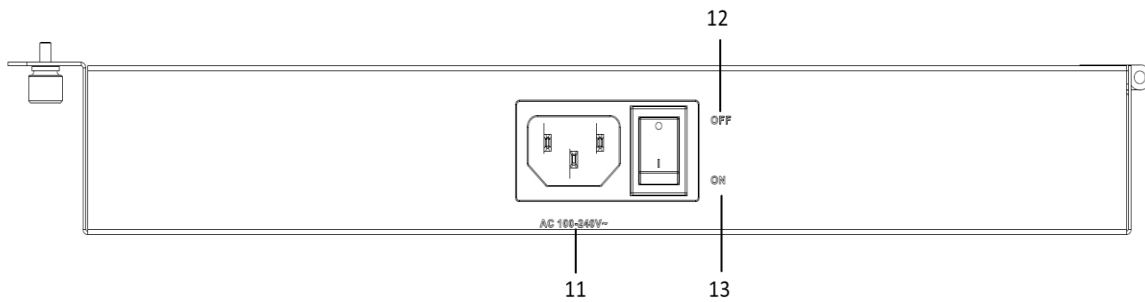



Figure 2-36 Interfaces on the Rear Panel (2)

Table 2-3 Interfaces Description

No.	Name	Description
1	USB 2.0 Port	<p>Supports connecting to the mouse, keyboard, USB flash drive or USB plug of the RF remote control.</p> <p> Note</p> <p>You can use the program playing software to export the program file to the USB flash drive and insert the USB flash drive into the device to play the programs.</p>
2	USB 3.0 Port	<p>Supports connecting to the mouse, keyboard, USB flash drive or USB plug of the RF remote control.</p> <p> Note</p> <p>You can use the program playing software to export the program file to the USB flash drive and insert the USB flash drive into the device to play the programs.</p>
3	Debugging network port (LAN)	Connects to the network cable for device debugging.
4	Loop output port (LOOP)	Connects to the HDMI IN port of the next device for signal loop output.
5	HDMI input port (HDMI 1.4 IN)	Connects to a signal source that uses the HDMI port with a resolution of 2K.
6	IR input port (IR IN)	3.5 mm interface for connecting to the IR device.
7	Audio output port (LINE OUT)	3.5 mm interface for audio output.
8	Console port (CONSOLE)	Connects to the serial port cable for device debugging.
9	RS-485 port (RS485)	Connects to the RS-485 port of central control device.
10	Wireless port (WIFI)	Supports connecting to the Wi-Fi antenna.
11	Power supply socket (AC 100-240V~)	Connects to the power cord.
12	OFF	Turn off the device.
13	ON	Turn on the device.

Chapter 3 Prerequisite Configuration

3.1 Activate and Log In to the Device

You should activate the device before using the device for the first time. When activating the device, obey the following requirements to set the password:

- To improve system security, it is highly recommended to change password regularly. In order to protect your privacy and corporate data and avoid network security issues, it is recommended to set strong password that meets security requirements.
- Password should contain 8 to 16 characters and at least 2 of the following types: digits, lowercase letters, uppercase letters, and special characters.
- Password cannot contain user name, 123, admin, 4 or more continuously ascending or descending digits, or 4 or more consecutive repeated characters.
- The password cannot be 1qaz2wsx, 1qaz@WSX, !@#\$QWER, p@ssword, passw0rd, or p@ssw0rd.

Activate the Device via SADP Client

Step 1 Connect the device and computer to the same LAN. Make sure the device and computer in the same network segment.

Step 2 Download and install the [SADP client](#) on the computer.

Step 3 Open the SADP client.

Step 4 Select the device that is not activated, enter the activation password and confirm it, and click **Activate**.

If the device cannot be found, you can restart the SADP client.

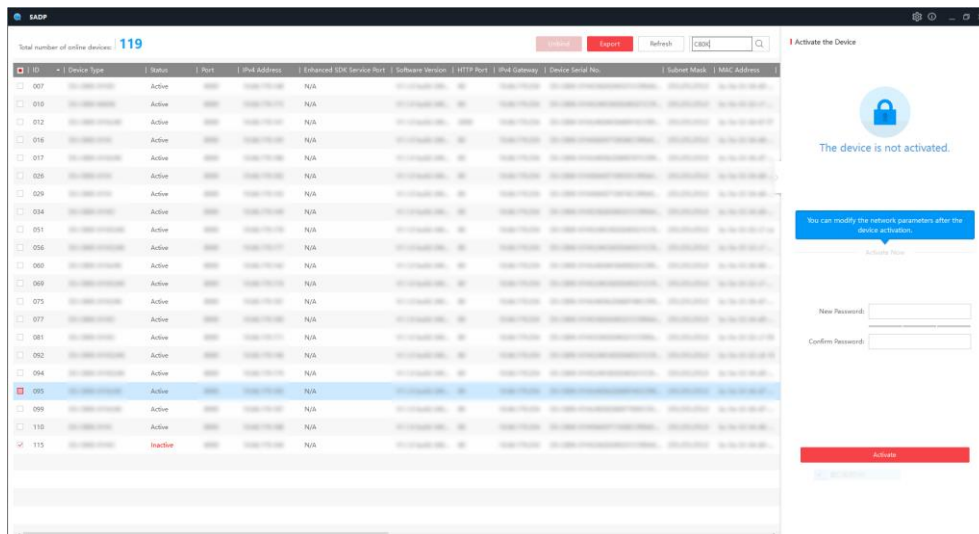

Figure 3-1 Activate the Device via SADP Client

Step 5 View the device IP address in- the SADP client and enter the device IP address in the computer browser.

Step 6 Enter the user name and the activation password you set, and then click **Log In**.

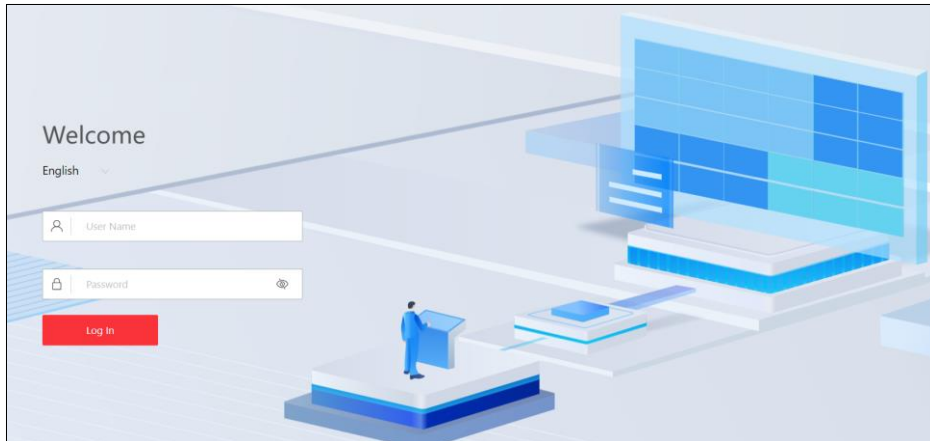

Figure 3-2 Login Page

Step 7 (Optional) To edit the password, you can click the username in the upper right corner of the web page and then click **Change Password**.

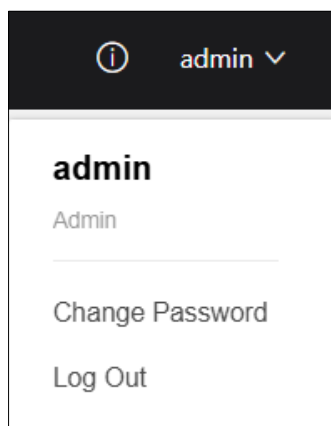

Figure 3-3 Change Password

Activate the Device via Web Browser

Note

- Supports only Chrome, Edge, Firefox, and Safari browsers. The Internet Explorer browser is not supported.
- Make sure the computer and device are in the same subnet.

Step 1 Use a network cable to connect a computer to the device.

Step 2 Set the computer IP address to any IP address in the range of 192.0.0.2 to 192.0.0.253 (excluding 192.0.0.64) and set the computer gateway address to 192.0.0.1.

By default, the device IP address is 192.0.0.64 and the gateway address is 192.0.0.1.

Step 3 Enter 192.0.0.64 in the computer browser to enter the device activation page.

Step 4 Set the activation password, and then click **Activate**.

Step 5 Enter the user name and the activation password you set on the login page, and then click **Log In**.

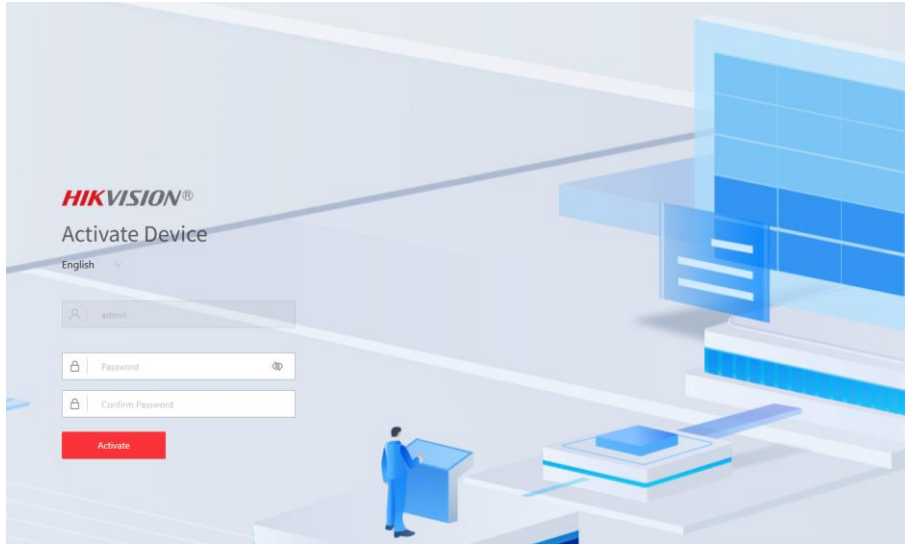

Figure 3-4 Login Page

Step 6 (Optional) To edit the password, you can click the user name in the upper right corner of the web page and then click **Change Password**.

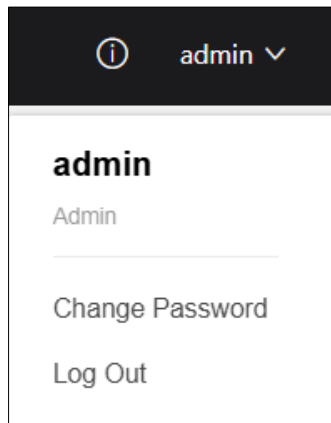

Figure 3-5 Change Password

Step 7 Remove the network cable that connects the device and computer, use the network cable to connect the device to the on-site network, and connect the computer to the on-site network through network cable or Wi-Fi.

After joining the on-site network, the device will be assigned with a new IP address automatically.

Step 8 Enter the new IP address of device in the web browser of the computer to log in to the web page of the device.

3.2 Lighten the Device

The device can be lightened automatically after being powered on. If the screen is not lightened up automatically, please perform operations as follows.

- 1) Import Receiving Card Parameters.
- 2) Lighten the Screen.
- 3) Firstly Correct Receiving Cards.

3.2.1 Import Receiving Card Parameters

Step 1 Go to **Screen Lightening Configuration**.

Step 2 Choose any of the following methods to import the receiving card parameters:

- Select **Load from Screen**, and click **Load**.
- Select **Load From Cloud**, enter the serial number, click **Search** and then select a configuration file. Click **Load**.
- Select **Import File**, click  to import a file, and then click **Load**.

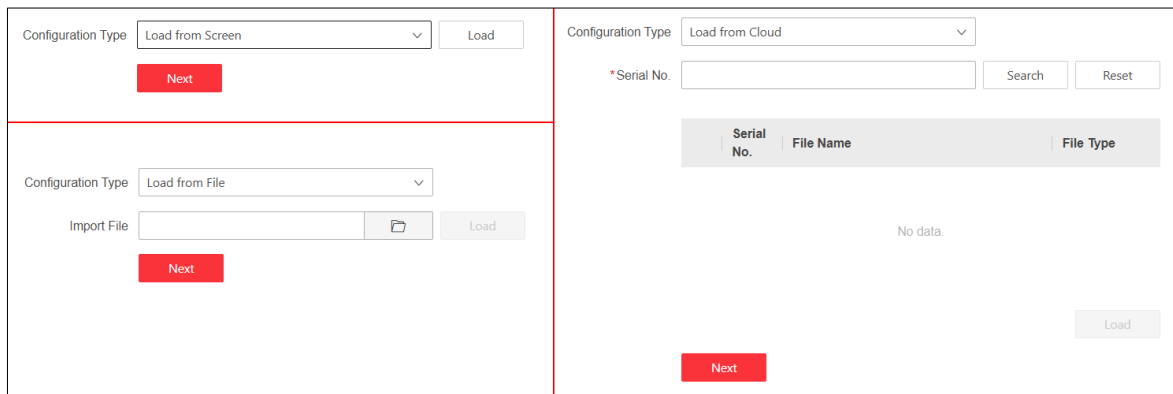

Figure 3-6 Import Receiving Card Parameters

Step 3 Click **Next**.

3.2.2 Lighten the Screen

Step 1 Enable **Show Connection**.

Step 2 Click **Edit** to set the screen size and resolution, and click **OK**.

- For a normal screen, set the screen size and resolution as follows:
 - Set the screen size based on the receiving card quantity. Make sure that the product of the row value and column value is greater than or equal to the actual receiving card quantity. Each cabinet contains one or two receiving cards.

- Set the resolution according to the actual screen resolution.
- For an ultra-long screen, calculate the screen size and resolution based on the actual screen resolution, cabinet resolution, and device load limitations.
 - The total loading resolution of the device cannot exceed 1920 × 1200 pixels, and the single-fold length cannot exceed 4094 pixels.

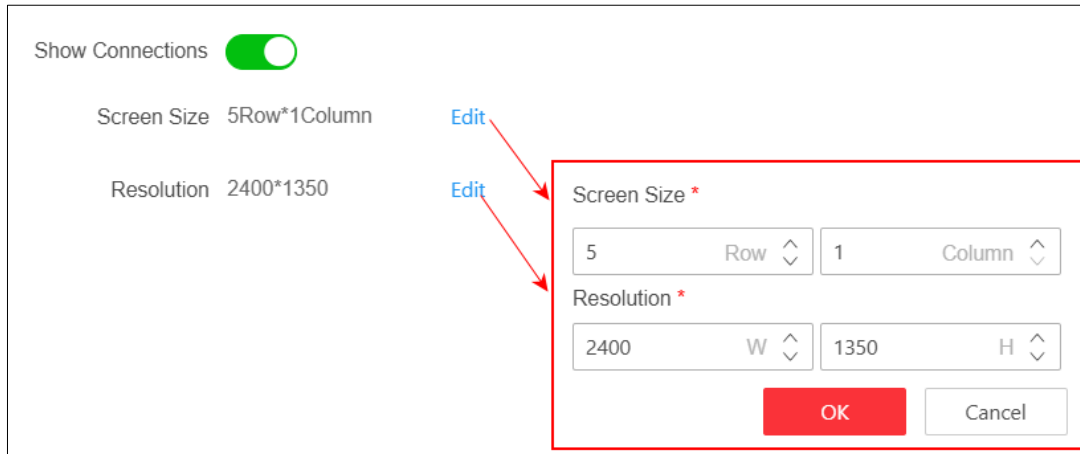

Figure 3-7 Edit Screen Size and Resolution

Step 3 According to the connection number shown on the screens, configure the signal connection of the device.

- 1) Select a network interface of the device.
- 2) Take either of the following methods to configure signal connection for the selected network interface:
 - Click to select screens and connect them in the order of operation. The connection can span different network interfaces of the device.
 - Click a screen to set as the start point of the connection and hold a screen to select the connection range. Batch connect screens in the order of operation. The connection can span different network interfaces of the device. If the start point and end point are not on the same row or column, the connection will be S-shaped in the order of operation.
- 3) (Optional) You can perform the following operations as required:
 - Click **Undo** to undo the previous operation.
 - Click **Restore** to restore the previous operation.
 - Click **Clear Current Sending Port Connection** to clear the signal connection of the current network interface.
 - Click **Clear All Sending Port Connection** to clear the signal connection of all network interfaces.
- 4) Use the same method to configure signal connection for other network interfaces.

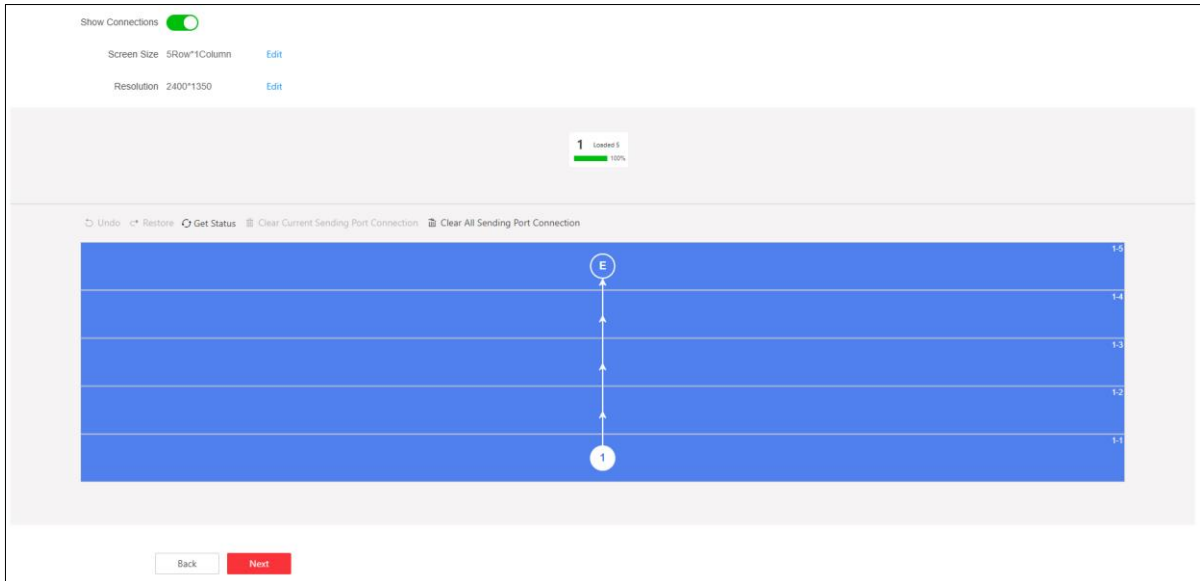

Figure 3-8 Lighten the Screen

Step 4 Click **Next**.

3.2.3 Firstly Correct Receiving Cards

Enable correction to load the lamp board data to the receiving cards.

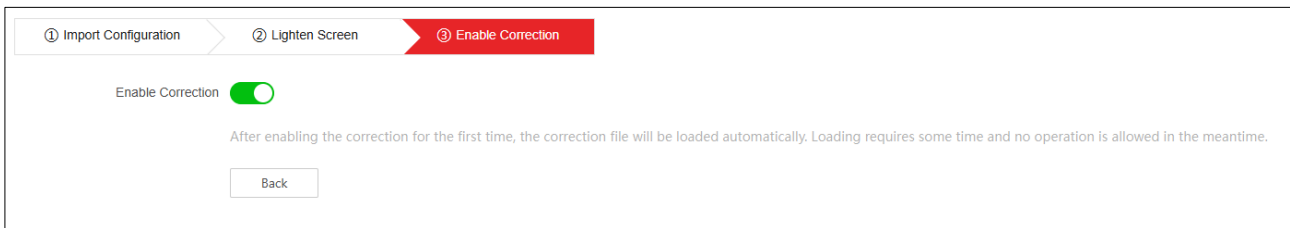

Figure 3-9 Firstly Correct Receiving Cards

Chapter 4 Screen Parameters Configuration

4.1 Correct Receiving Cards



Step 1 Go to **Configuration** → **Receiving Card Correction**.

Step 2 Click **Enable Correction**.

Step 3 According to the actual need and lamp board capacity, check the correction content and enable correction to start the configuration of correction parameters. The correction content includes brightness chroma correction and low gray correction. Only some lamp boards support low gray correction.

Step 4 (Optional) If you cannot locate the faulty screen area easily, you can enable **Show Connections** to show the connection number of the receiving cards on the screen.

Step 5 Set the correction areas.

- Click  and select the areas to be corrected.
- Click  and enter the start coordinate and end coordinate.

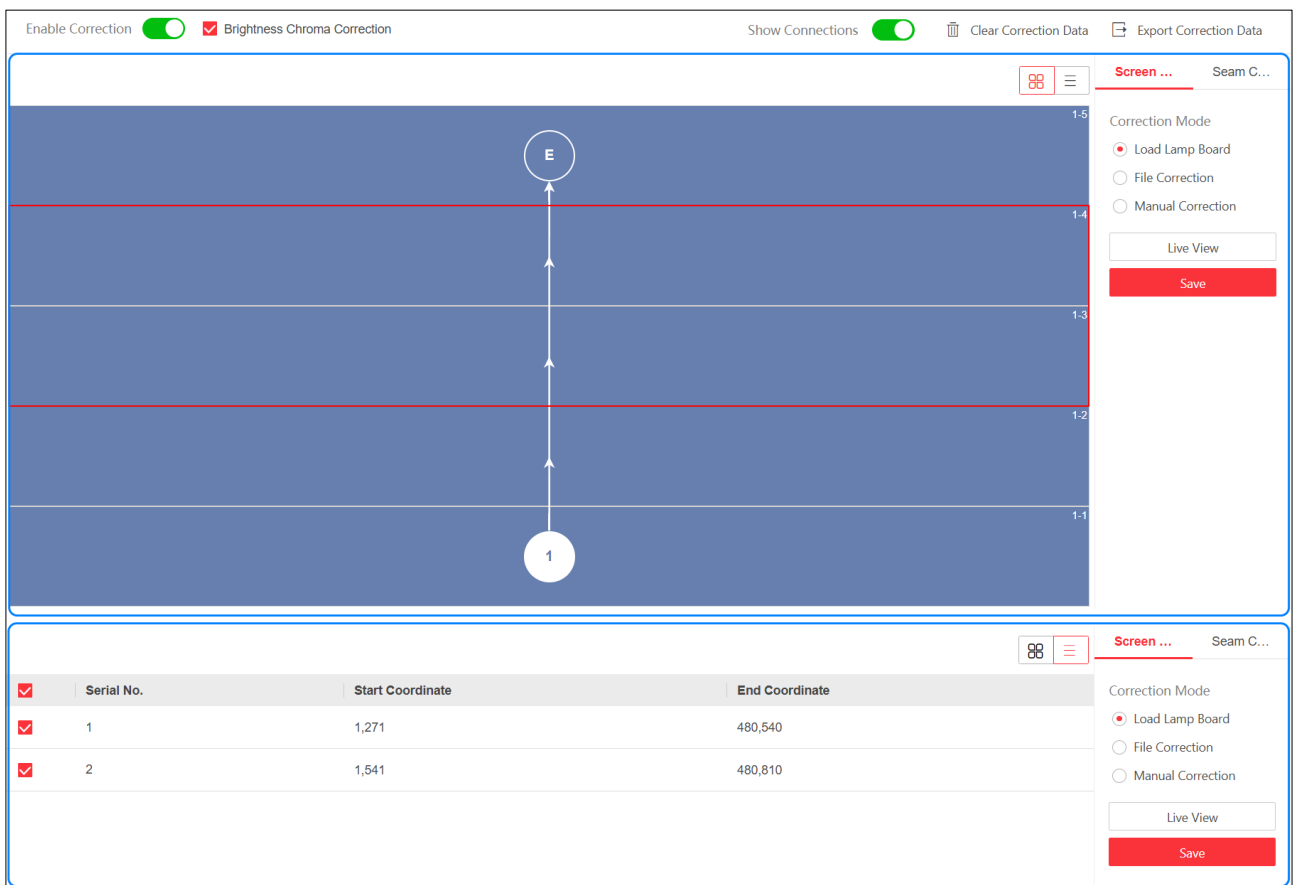

Enable Correction Brightness Chroma Correction Show Connections Clear Correction Data Export Correction Data

Screen ... Seam C...

Correction Mode

Load Lamp Board

File Correction

Manual Correction

Live View

Save

Serial No.	Start Coordinate	End Coordinate
1	1,271	480,540
2	1,541	480,810

Screen ... Seam C...

Correction Mode

Load Lamp Board

File Correction

Manual Correction

Live View

Save

Figure 4-1 Set Correction Areas

Step 6 Correct the defective pixels:

- 1) Select **Load Lamp Board** to load the lamp board data to the receiving cards.
- 2) If the display effect still does not meet the requirements, select **File Correction** to upload a locally saved correction file.
- 3) If the display effect still does not meet the requirements after loading the correction file, manually correct the screen area. Enable **Sync Adjustment** to synchronize the red, green, and blue percentages to the same value.
 - If the color difference exists, select **Manual Correction** and adjust the RGB values.
 - If bright or dark seams exist, select **Seam Correction**, set the seam direction and width, and adjust the RGB values.

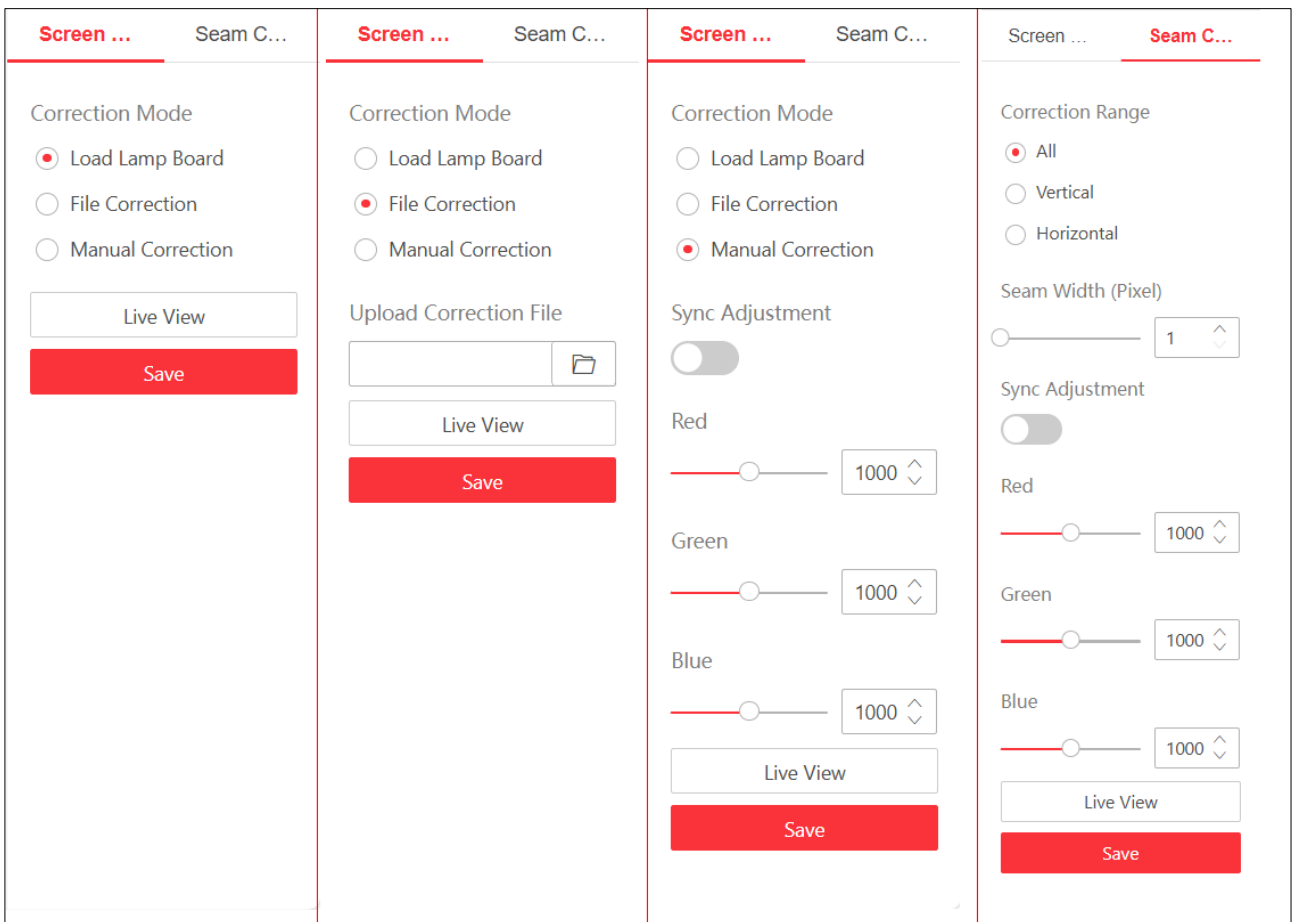

Figure 4-2 Correct Receiving Cards

Step 7 Click **Live View** to preview the display effect.

Step 8 When the desired display effect is reached, click **Save**.

Step 9 (Optional) You can perform the following operations as required:

- If the correction effect does not meet the requirements, click **Clear Correction Data** and select the correction areas to clear the correction data of the selected areas.

- Click **Export Correction Data** and select the correction areas to export the correction data of the selected areas.

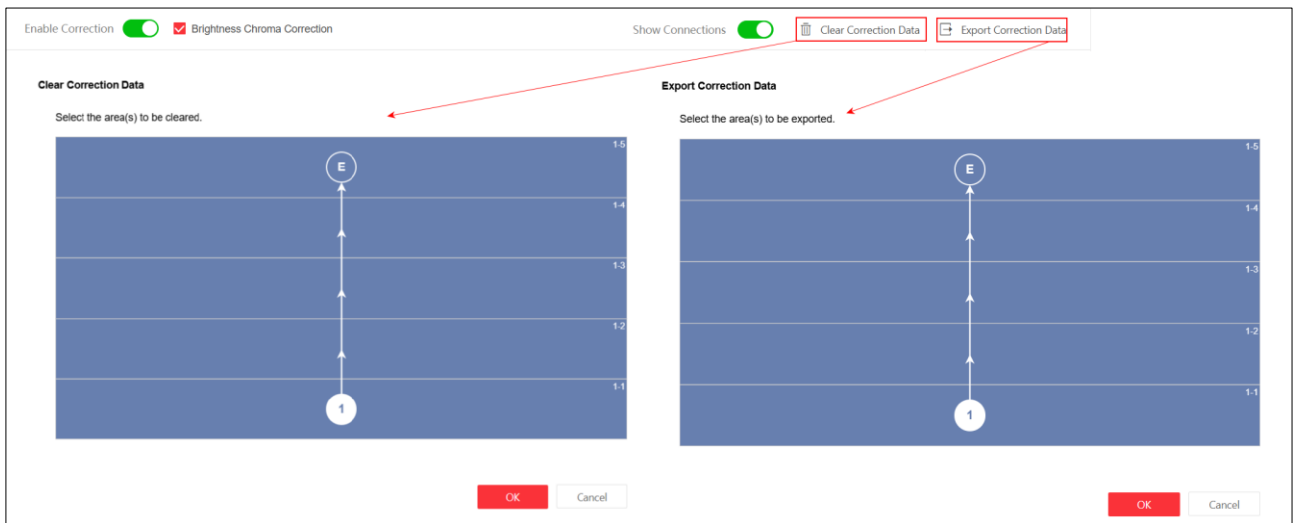

Figure 4-3 Clear/Export Correction Data

4.2 Configure Signal Source Parameters

Step 1 Go to **Configuration** → **Signal Configuration**.

Step 2 Configure the input signal:

- 1) Select a signal source.
 - When a device has multiple signal sources, only the selected signal source can be output to the screen.
 - You can select **AUTO** to allow outputting the newly connected signal source to the screen.
- 2) Set the resolution or enable **Resolution Self-Adaption**.

Step 3 Configure the output signal:

- 1) Select a zoom mode.
- 2) Adjust the device audio volume and turn off the audio as required.

Step 4 Click **Save**.

Set Input Signal

Signal Source

Input Source Parameter 1920*1200@60HZ@8bit

Resolution Self-Adaption

Set Output Signal

Zoom Mode Pixel-to-Pixel Mode Full Screen Zoom

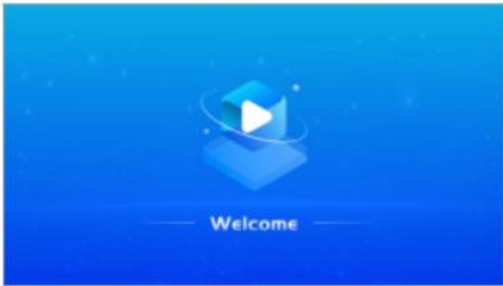

Input Resolution: 1920*1200 Output Resolution: 480*1350

Audio

Volume 64

Figure 4-4 Configure Input/Output Signal

4.3 Configure Image Effect

4.3.1 Configure Display Effect of Screen

Step 1 Go to **Configuration** → **Display Effect**.

Step 2 Select a preset mode.

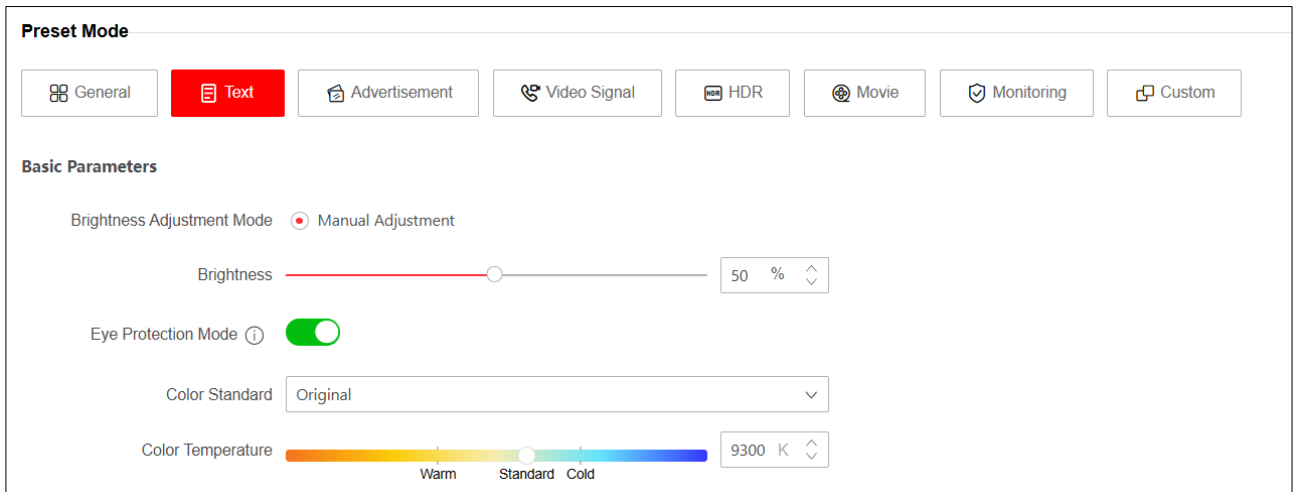

Figure 4-5 Select a Preset Mode

Step 3 If the current preset mode parameters do not meet the requirements, edit the corresponding parameters and click **Save**.

- Enable **Eye Protection Mode** to reduce brightness and power consumption.
- Choose a color standard.
- Set the color temperature.
- Set the contrast mode.
- Set the Gamma coefficient: A smaller Gamma coefficient makes the low gray areas brighter, while a larger Gamma coefficient makes the low gray areas darker.
- Set the ambient brightness: When the ambient light is brighter, set a higher ambient brightness value.
- When low gray effect is abnormal, adjust the initial brightness level.
- When the low gray effect is poor, increase the initial brightness value.
- Enable **Frame Rate Adaptation**.
- Enable **Gray Scale Optimization** to make the screen gray display more uniformly.

Advanced Parameters

Contrast Mode ⓘ

Gamma Coefficient ⓘ

Ambient Brightness ⓘ

Initial Brightness Level ⓘ

Initial Brightness ⓘ

Frame Rate Adaptation ⓘ

Gray Scale Optimization ⓘ

Figure 4-6 Configure Advanced Parameters of Display Effect

Step 4 (Optional) Click **Restore Preset** to restore the default parameters of the selected preset mode.

4.3.2 Configure Startup Image

Step 1 Go to **Configuration** → **Customization** → **Startup Image**.

Step 2 Select an image as the startup image, and click **Save**.

- **Current Image:** The current image will be used as the startup image.
- **Custom:** You can click to upload an image to function as the startup image.

Image Type Current Image Custom None

Custom Image

+
Add Image

Only the image meeting the following requirements is allowed: format JPEG/JPG, width 640~3840 px, height 480~2160 px, resolution 307200~2073600 px, and size less than 2 MB.

Save

Figure 4-7 Configure Startup Image

4.3.3 Configure No Signal Images

Step 1 Go to **Configuration** → **Customization** → **No Signal Image**.

Step 2 Select images to display when the signal interruption occurs, and click **Save**.

- Last Frame: The last frame image will be displayed when the signal interruption occurs.
- Aging Mode: The display enters random solid color mode and flashes regularly when the signal interruption occurs.
- Custom Picture: Click  to upload an image to display when the signal interruption occurs.
- Black Screen: The screen color will turn into black when there is no signal input.

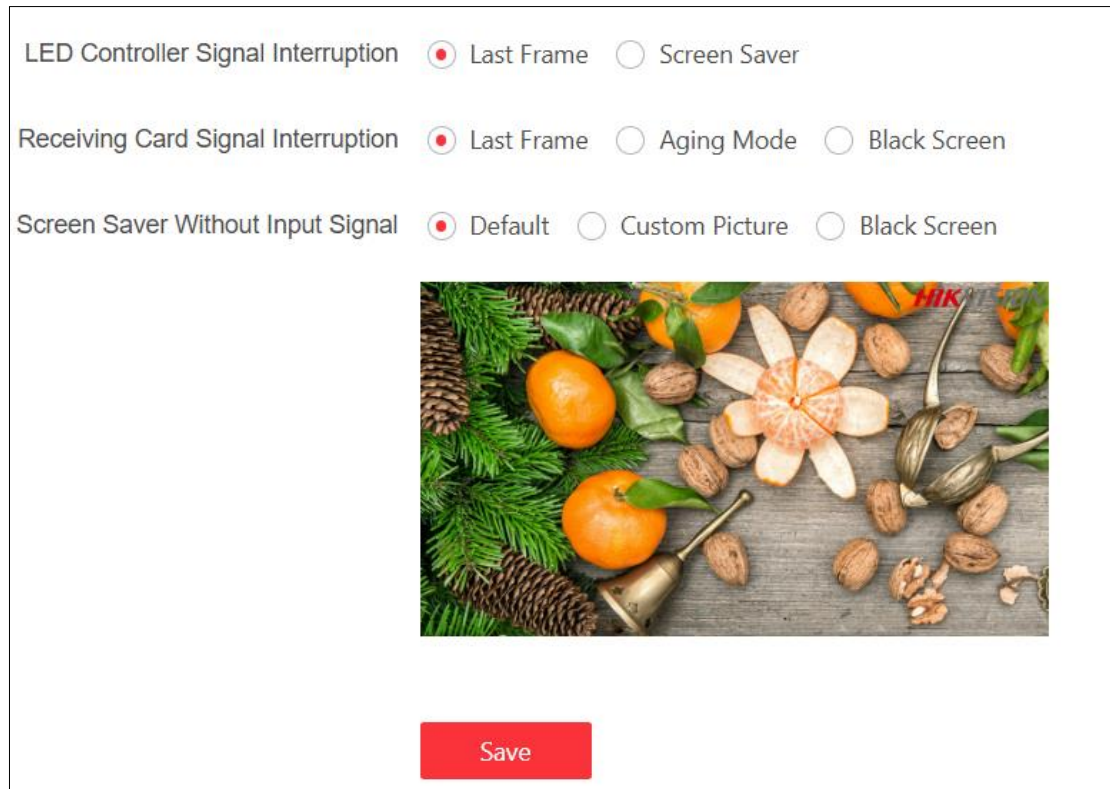

Figure 4-8 Configure No Signal Images

4.3.4 Configure Screen Splicing

Step 1 Go to **Configuration** → **LED Poster Display Splicing**, you can view the splicing status of the screens.

Step 2 Configure screen splicing.

- If the splicing status is **Spliced**, click **Cancel Splicing**, the splicing of spliced screens will be cancelled.
- If the splicing status is **Not Spliced**, you can splice the screens on GUI page. For details, see **7.2.2 Splice Screens on GUI Page**.

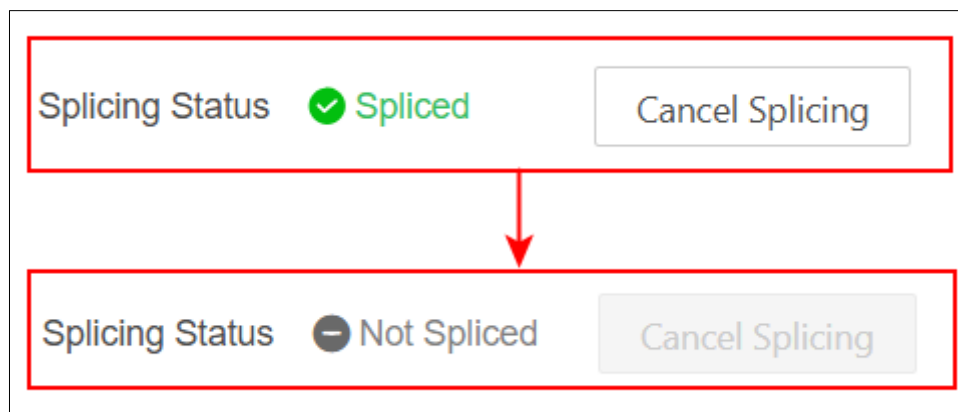

Figure 4-9 Configure Screen Splicing

4.4 Configure General Parameters

4.4.1 Configure Time for the Device

Step 1 Go to **Configuration** → **System** → **Time Settings**.

Step 2 Select a time zone.

Step 3 Select the Time Sync Mode.

- Select **NTP Sync**, enter the NTP server address, NTP port number, and interval.
- Select **Manual Time Sync**, and then set the time manually or click **Sync with Computer Time** to make the device time consistent with the computer time.

The figure shows two side-by-side screenshots of the 'Time Settings' configuration page. Both show the 'Device Time' as 1970-01-07 09:43:36. The left screenshot shows 'Time Sync Mode' set to 'NTP Sync' (indicated by a red dot). Below this are three input fields: '*Server Address', '*NTP Port', and '*Interval' (with a 'min' unit). A red 'Save' button is at the bottom. The right screenshot shows 'Time Sync Mode' set to 'Manual Time Sync' (indicated by a red dot). Below this is a 'Set Time' field containing '1970-01-07 09:43:26' and a 'Sync With Computer Ti...' button. A red 'Save' button is also present at the bottom.

Figure 4-10 Configure Time for the Device

4.4.2 Configure Hot Spare for the Device

Step 1 Go to **Configuration** → **Hot Spare Configuration** → **Data Port Backup**.

Step 2 Enable **Data Port Backup**.

The figure shows the 'Data Port Backup' configuration page. At the top left, the text 'Data Port Backup' is followed by a green toggle switch that is turned on. Below this is a large, empty rectangular box. In the center of this box is a green icon of a server rack with the number '1' on top, and a double-headed arrow below it.

Figure 4-11 Configure Data Port Backup

4.4.3 Configure Alarms

Go to **Configuration** → **Environment and Alarm**, monitor the following items as required and set the thresholds:

- When the threshold is exceeded, the alarm information and current value of the monitored item will be displayed on the display and the device web interface.
- After the receiving card connects to a temperature and humidity sensor, you can monitor the environmental temperature and humidity.

Alarm Threshold

Cabinet Voltage Detection

Cabinet Voltage Low Threshold 3.6 V

Cabinet Voltage High Threshold 4.6 V

Cabinet Temperature Detection

Cabinet Temperature Threshold 76 °C

LED Controller Temperature Detection

LED Controller Temperature Threshold 70 °C

Ambient Temperature Detection

Ambient Temperature Threshold 50.2 °C

Ambient Humidity Detection

Ambient Humidity Threshold 80 %RH

Save

Figure 4-12 Configure Alarms

4.4.4 Configure Timed Parameters

Step 1 Go to **Configuration** → **Schedule**.

Step 2 On the **Timed Screen On/Off** page, enable the function and set the screen on time and screen off time.

Step 3 Click **Timed Brightness Adjustment**, enable the function, and set the target brightness value and duration.

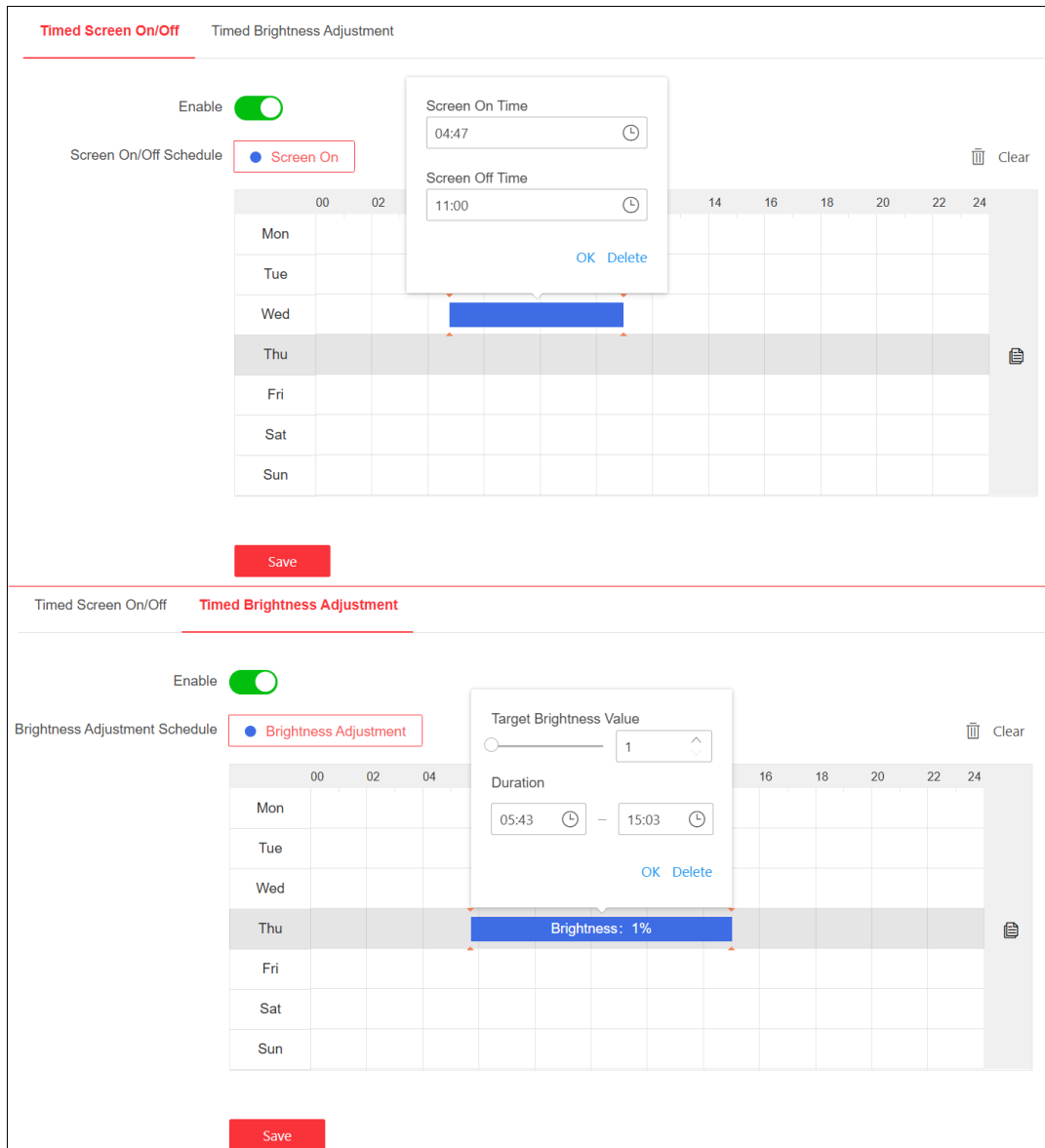

Figure 4-13 Configure Timed Parameters

4.5 Configure Network Parameters

4.5.1 Configure Wired Network Address

Step 1 Go to **Configuration** → **Network** → **TCP/IP**.

Step 2 Enable **Static IP Address**.

Step 3 Set the static wired IP address:

- If the device is directly connected to the computer, set an unused IP address from the local network as the wired network address of the device. Ensure that the device can still connect to the local network and remain on the same subnet as the computer.

- If the device is connected to the local network via an Ethernet cable, the device will automatically obtain an IP address. You can set the automatically obtained IP address as the wired network address of the device, or set an unused IP address from the local network as the wired network address of the device. Ensure that the device and computer are on the same subnet.

Step 4 Click **Save**.

Step 5 Enter the configured wired IP address of the device in the browser of the computer to log in to the device web page.

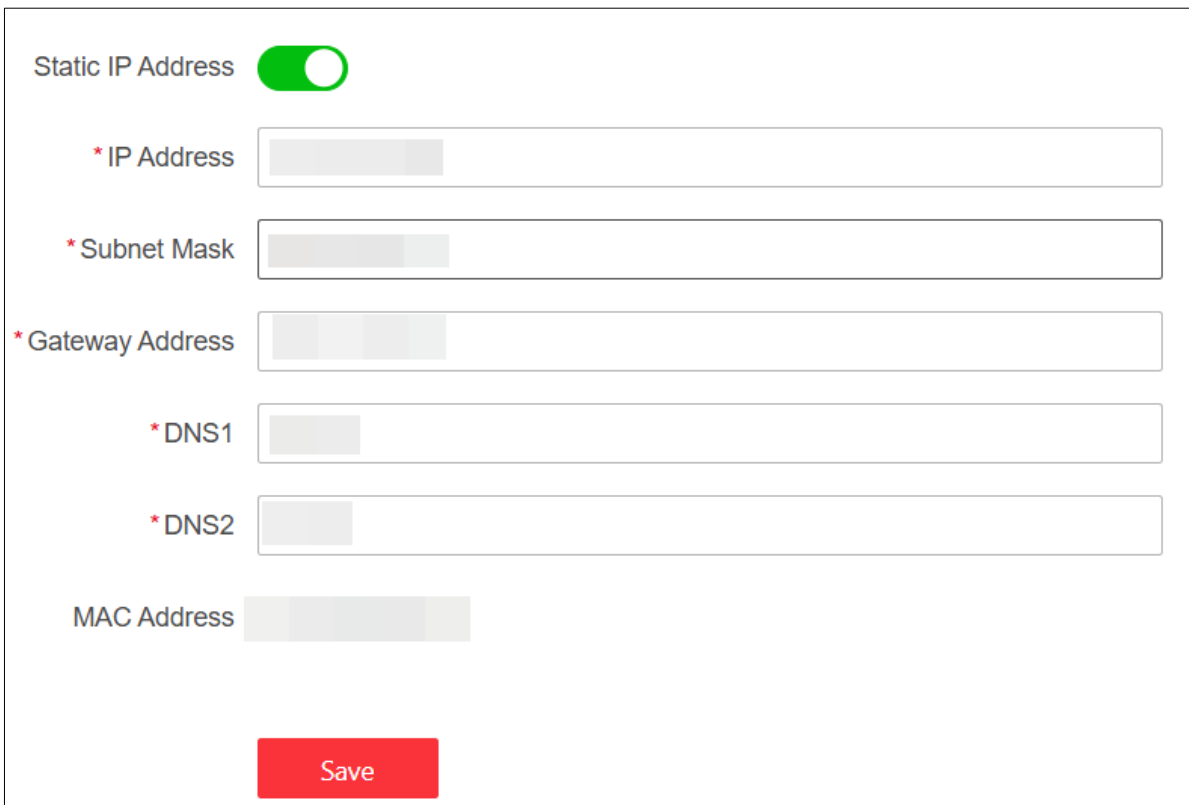

The screenshot displays a network configuration form. At the top, there is a toggle switch for 'Static IP Address' which is turned on (green). Below this are several input fields, each with a red asterisk indicating a required field: '* IP Address', '* Subnet Mask', '* Gateway Address', '* DNS1', and '* DNS2'. At the bottom of the form is a red 'Save' button. The MAC Address field is also visible but does not have an asterisk.

Figure 4-14 Configured Wired Network Address

4.5.2 Configure Wireless Network Address

When activating and logging in to the device for the first time, a wired connection must be used. If the device is connected to both a wired and wireless network simultaneously, it will prioritize the wired network.

Step 1 Connect a Wi-Fi antenna to the WIFI STA port of the device.

Step 2 Go to **Configuration** → **Network** → **Wi-Fi** and enable Wi-Fi.

Step 3 Select an available Wi-Fi network and click **Connect**.

Step 4 Click **Network Status** to view the IP address automatically obtained by the device after the device connects to the wireless network.

Step 5 Enable **Static IP Address**.

Step 6 Set the static wireless IP address:

- Set the automatically obtained IP address as the wireless network address of the device.
- Set an unused IP address from the local network as the wireless network address of the device. Ensure that the device and computer are on the same subnet.

Step 7 Click **Save**.

Step 8 When the wired network is unavailable or the Ethernet cable is removed, enter the configured wireless IP address of the device in the browser of the computer to log in to the device web page.

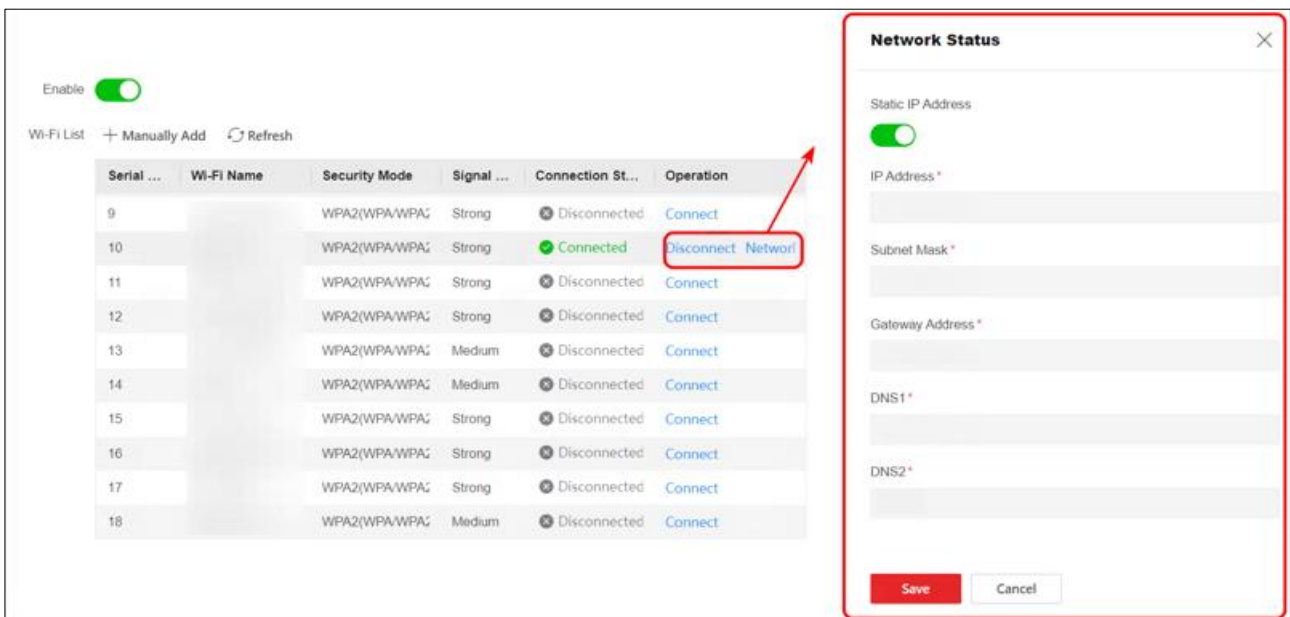

Figure 4-15 Configure Wireless Network Address

4.5.3 Configure Bluetooth

Step 1 Connect a Wi-Fi antenna to the WIFI STA port of the device.

Step 2 Go to **Configuration** → **Network** → **Bluetooth** and enable Bluetooth.

Step 3 Use Bluetooth to connect the device to other devices:

- Select a Bluetooth device, click **Pair**. The Bluetooth device is paired after the pairing is successful.
- Select Bluetooth peripheral device, click **Pair**. The Bluetooth device is paired after the pairing is successful. Click **Connect** to connect the Bluetooth peripheral device to the device. The Bluetooth peripheral device is connected after the connection is successful.

Step 4 Click **Save**.

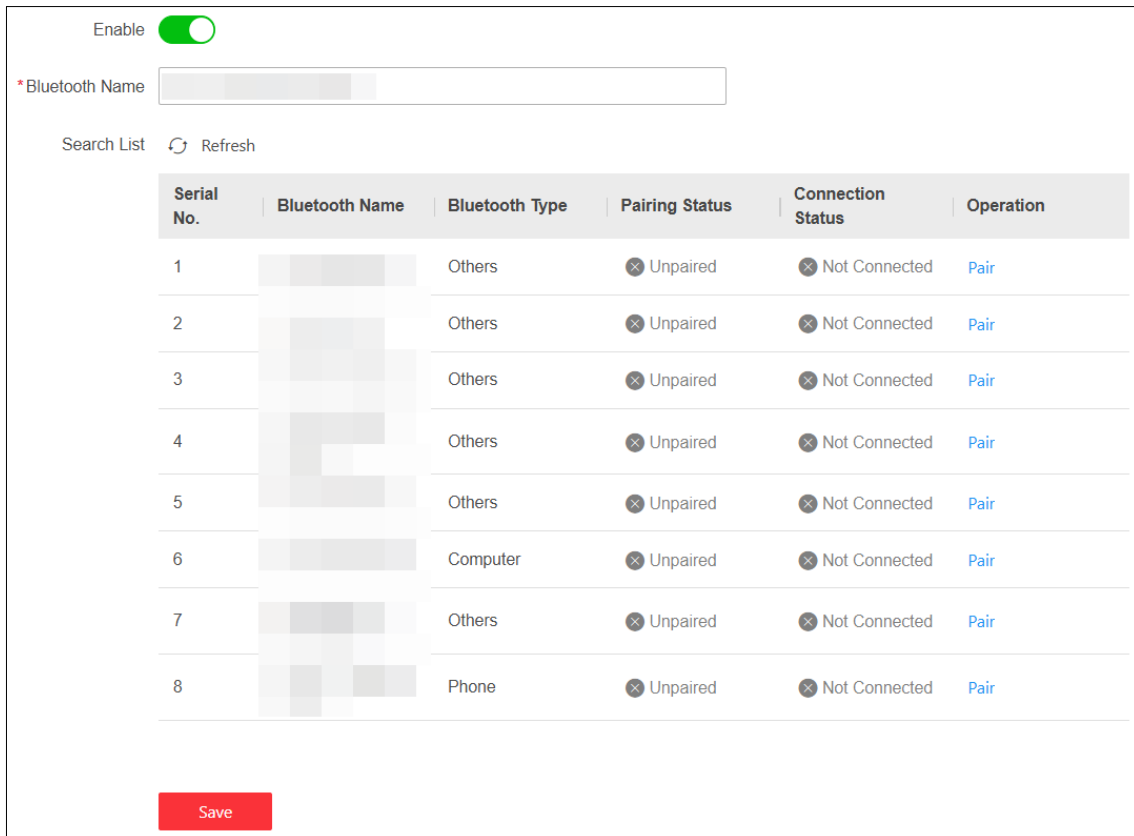

Figure 4-16 Enable Bluetooth

4.5.4 Configure Hot Spot

Step 1 Connect a Wi-Fi antenna to the WIFI AP port.

Step 2 Go to **Configuration** → **Network** → **Hot Spot** and enable hot spot.

Step 3 (Optional) Configure hot spot parameters as required:

- After hot spot is enabled, the default name and password are used. You can edit the hot spot name and password.
- Edit the security, AP band, or AP channel.

Step 4 Click **Save**.

Enable

* Name

Security WPA2-PSK

* Password

AP Band 2.4GHz

AP Channel 6

Figure 4-17 Configure Hot Spot

4.6 Configure Auto Dehumidification

Step 1 Go to **Configuration** → **Dehumidification**.

Step 2 Enable **Auto Dehumidification** and set the dehumidification parameters.

Step 3 Select the region according to the actual humidity condition of the device location. If you select **Custom**, set the time step, brightness step and duration.

- **Time Step:** The time interval between two consecutive brightness adjustments by the LED controller during a single dehumidification process. If the brightness is adjusted every 5 minutes, the time step is 5 minutes.
- **Brightness Step:** The minimum change in brightness for each adjustment by the LED controller during a single dehumidification process. If the brightness increases by 1 each time, the brightness step is 1.
- **Duration:** The total time of a single dehumidification process.
- **Usage Rate:** The usage rate of the device.

Step 4 Click **Save** or **Save and Start**.

The screenshot shows the 'Auto Dehumidification' configuration page. At the top, there is a green toggle switch for 'Auto Dehumidification'. Below it is a dropdown menu for 'Region' with 'Custom' selected. The dropdown menu is open, showing options: 'High Humidity', 'Medium Humidity', 'Low Humidity', and 'Custom' (highlighted in red). Below the dropdown are three input fields: '*Time Step' (empty), '*Brightness Step' (set to 1), and '*Duration' (empty). At the bottom left, it shows 'Usage 0%'. At the bottom right, there are two buttons: a red 'Save' button and a white 'Save and Start' button.

Figure 4-18 Configure Auto Dehumidification

4.7 Configure Loading Mode

Go to **Configuration** → **Loading Mode** to select a mode:

- **Standard Loading:** Select this mode when the device's single network port load exceeds 0.65 MP but does not exceed 2.925 MP. If you select this mode, the device will compress the images.
- **Mini Loading:** Select this mode when the device's single network port load does not exceed 0.65 MP. If you select this mode, the device will not compress the images.

The screenshot shows the 'Loading Mode' configuration page. It features a label 'Loading Mode' followed by two radio buttons: 'Standard Loading' (unselected) and 'Mini Loading' (selected). Below the radio buttons is a red 'Save' button.

Figure 4-19 Configure Loading Mode

4.8 Configure Cascading/Self-Splicing

Before You Start

LED Tool client has been installed, and the device has been added to the client.



For the operation on LED Tool client, please scan the QR code below to find the [user manual](#).



Figure 4-20 LED Tool Client User Manual

Steps

Step 1 Select an LED poster.

Step 2 Navigate to **Display Maintenance** → **Settings** → **Cascading & Self-Splicing**.

Step 3 Enable display cascading when multiple devices are cascaded.

With display cascading enabled, you can view the cascading status of each device.

Step 4 Enable **Show Device ID** to show the IP addresses and serial numbers of LED posters on the display.

Step 5 Configure self-splicing:

- 1) Navigate to **Display Control** → **Display Mapping** and position LED posters on the canvas.
- 2) Enable **Display Self-Splicing**. With display self-splicing enabled, you can view the self-splicing status of each device.

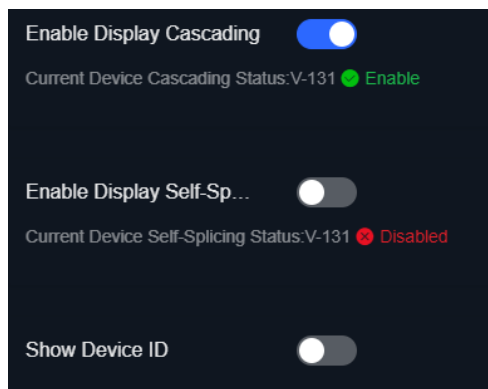

Figure 4-21 Configure Cascading/Self-Splicing Parameters

Chapter 5 Screen Content Configuration

You can create multiple programs to be played on the video wall. Each program can be bound to at least one material, and you can create a schedule to play the programs as planned.

5.1 Create and Play One Program

5.1.1 Create and Play One Normal Program

Step 1 Go to **Playing Control**.

Step 2 In the popped-up program creation window, select **Normal Program**, set the program name and program resolution, and select a template.

- After creating the program, you can click  on top of the page to change the program type, program name, program resolution, or template.
- If you click **Restore to Screen Size**, the actual size of the connected screen will be used as the program resolution.
- If you want to customize the layout, select **Blank Page**.

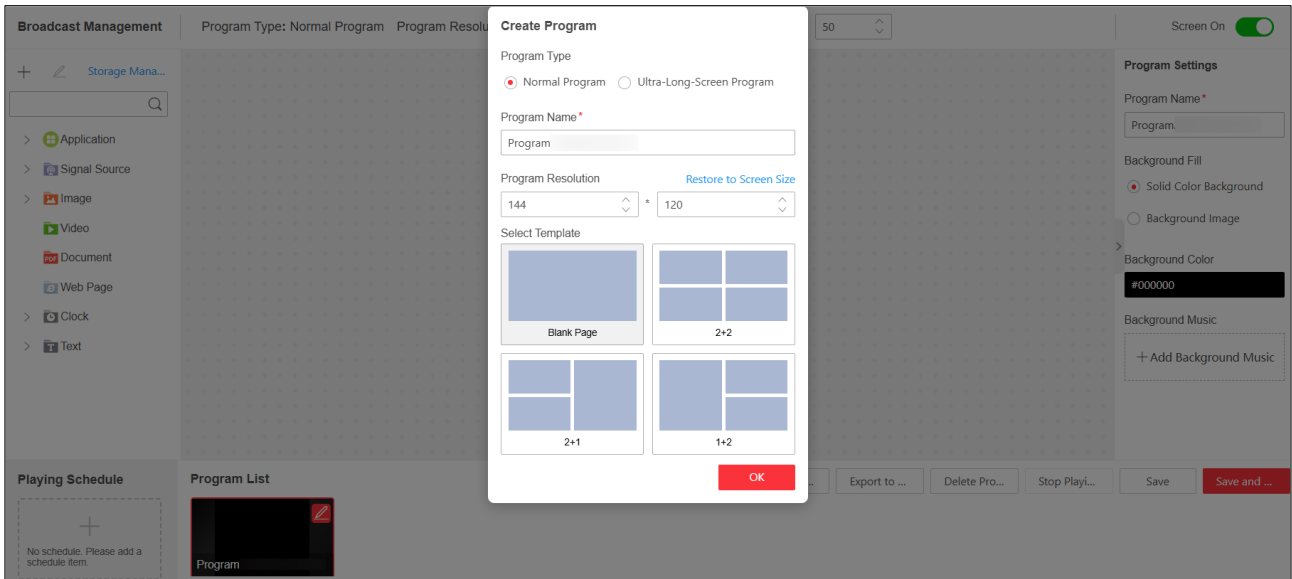

Figure 5-1 Create a Normal Program

Step 3 Click  to upload the locally saved materials or to add the web material.

- Normal programs support image, video, document, web page, clock, and text materials. You need to click **Local Upload** to upload the locally saved images, videos, and documents and click **Web Page** to add web pages. If you batch upload materials, make sure the total size of the uploaded materials does not exceed the remaining available storage space on the system.

- Supported image formats: BMP, JPG, PNG, and GIF.
- Supported video formats: ASF, AVI, MPG, 3GP, MOV, MKV, WMV, FLV, MP4, and RM.
- Supported document formats: PDF.
- The supported web pages must use HTTP or HTTPS as the prefix.

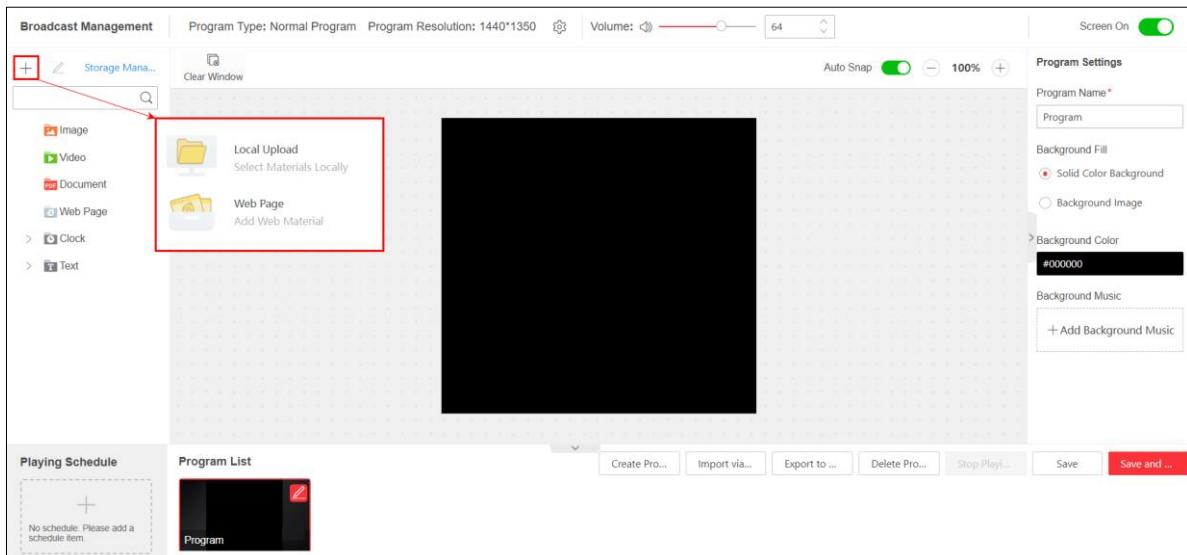

Figure 5-2 Add Materials for Normal Program

Step 4 Click and hold the left mouse button to drag a material to the program window. Repeat this operation to bind multiple materials with the program window.

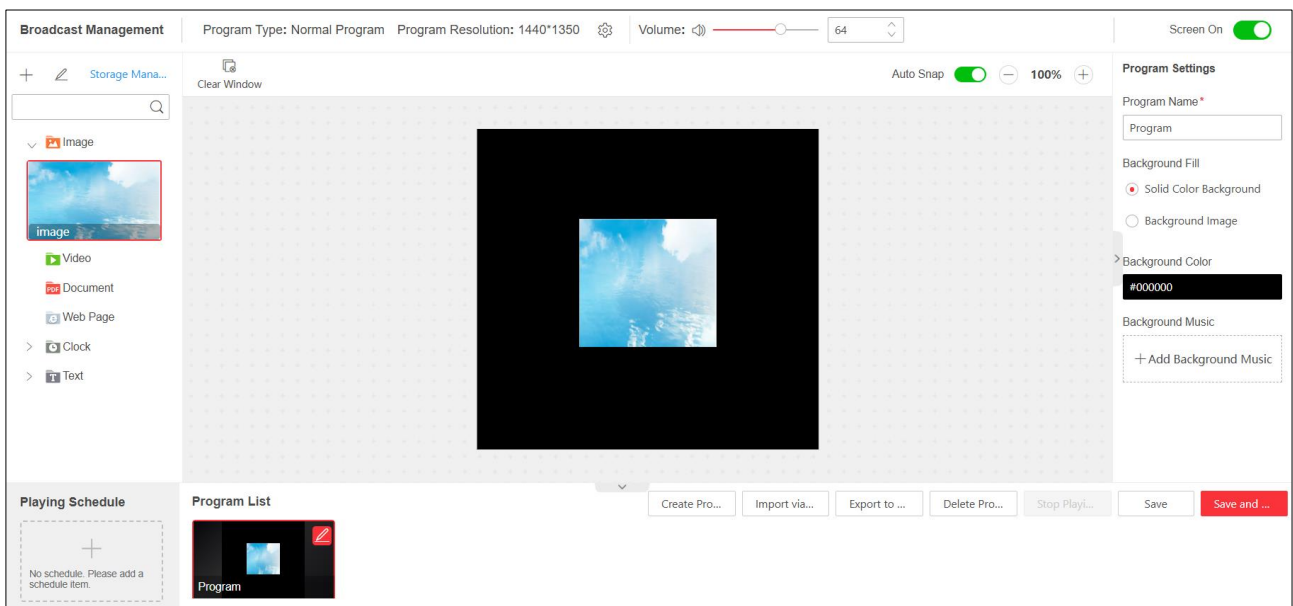





Figure 5-3 Bind Materials with Normal Program

Note

- To clear all bounded materials, click **Clear Window**.
- To edit the material name, select a material and click .
- By default, **Auto Snap** and **Screen On** are enabled. It is recommended to keep the default settings.
- A program supports only one clock.

Step 5 Click **Save and Release**.

- : the program is playing.
- : the program is being edited.

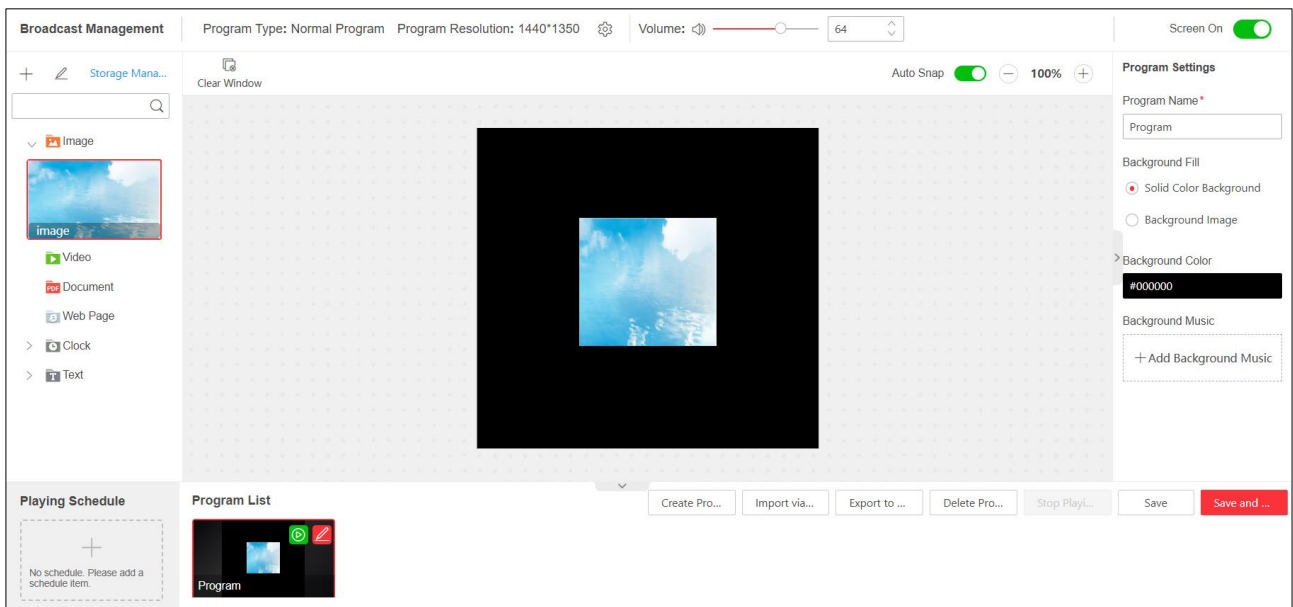

Figure 5-4 Release a Normal Program

5.1.2 Create and Play One Ultra-Long-Screen Program

When the width or height of an actual screen exceeds 4096 pixels, it is recommended to create an ultra-long-screen program.

Step 1 Go to **Playing Control**.

Step 2 In the popped-up program creation window, select **Ultra-Long-Screen Program**, and set the program resolution based on the actual screen resolution.

- The device automatically sets the number of folds based on the program resolution. The maximum number of folds cannot exceed 8.
- The total resolution loaded by the device cannot exceed 1920 × 1200 pixels, and the length of a single fold cannot exceed 4094 pixels.

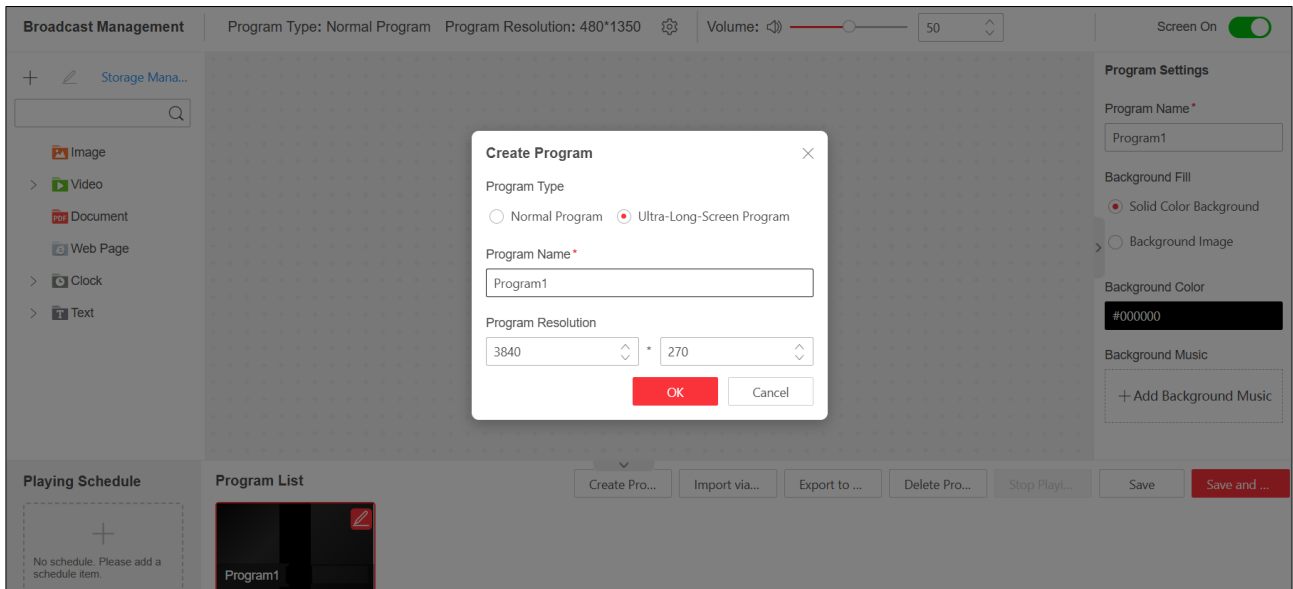

Figure 5-5 Create Ultra-Long-Screen Program

Step 3 Click **+** to upload the locally saved images. Supported image formats include BMP, JPG, PNG, and GIF.

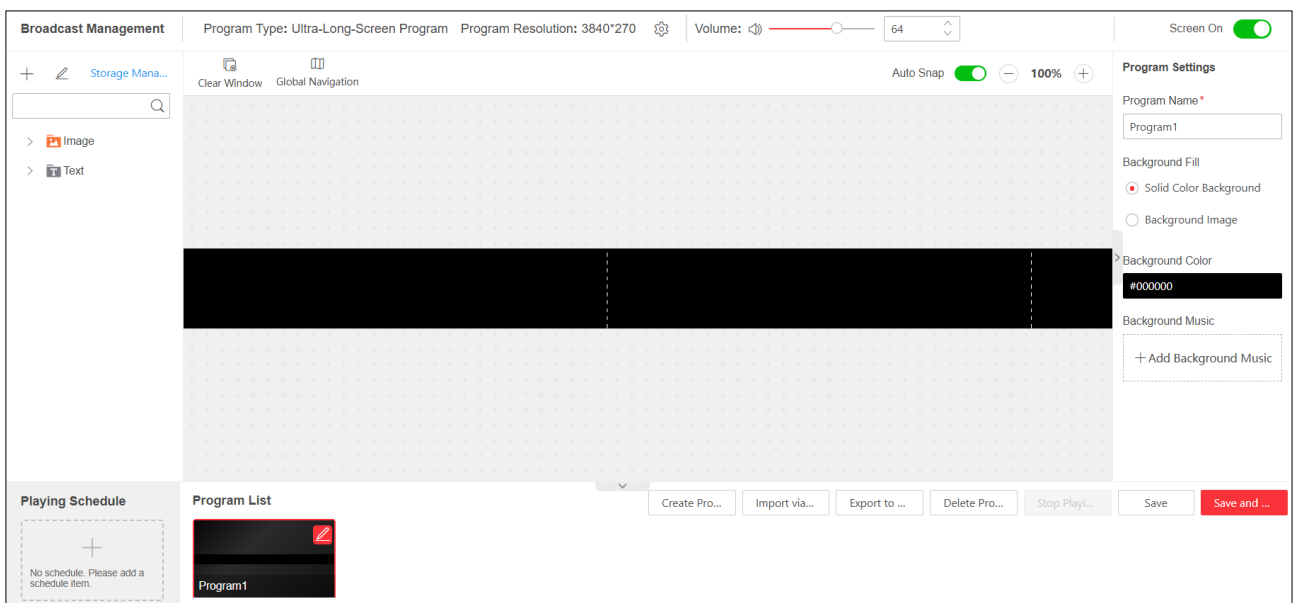

Figure 5-6 Add Materials for Ultra-Long-Screen Program

Step 4 Click and hold the left mouse button to drag a material to the program window. Repeat this operation to bind multiple materials with the program window.

- Each fold supports up to 8 materials.
- When a material crosses multiple folds, the maximum number of materials allowed in each fold decrease by 1.

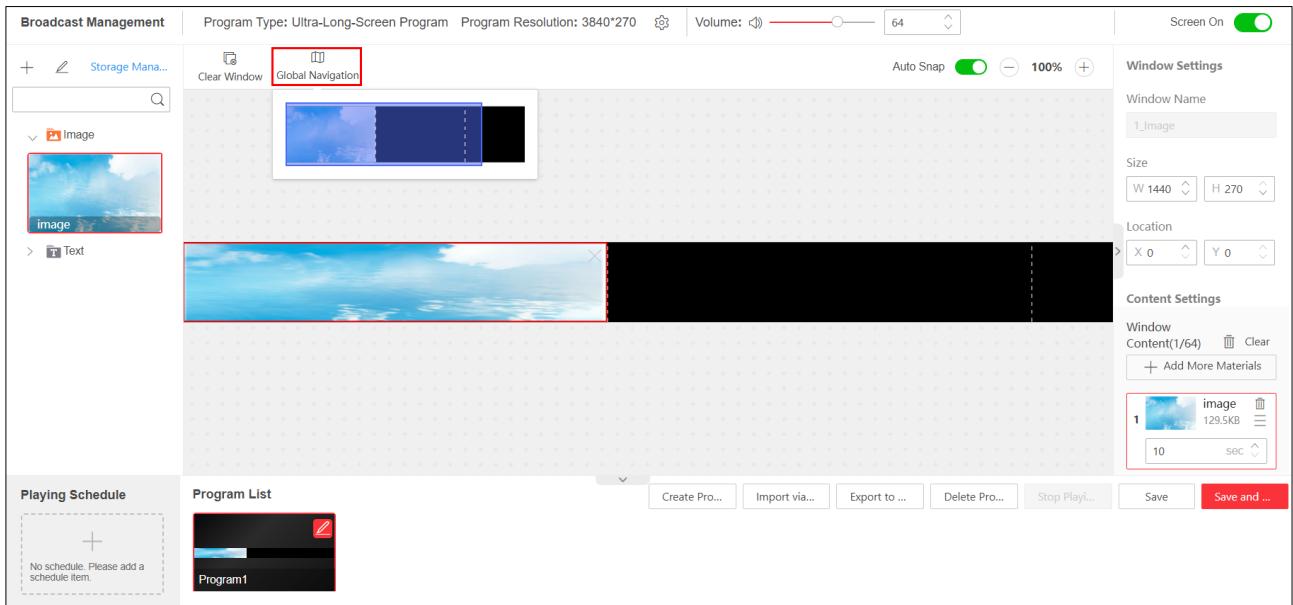





Figure 5-7 Bind Materials with Ultra-Long-Screen Program

Note

- To clear all bounded materials, click **Clear Window**.
- To edit the material name, select a material and click .
- By default, **Auto Snap** and **Screen On** are enabled. It is recommended to keep the default settings.
- For ultra-long-screen program, you can click **Global Navigation** to view the materials bound with each fold.

Step 5 Click **Save and Release**.

- : the program is playing.
- : the program is being edited.

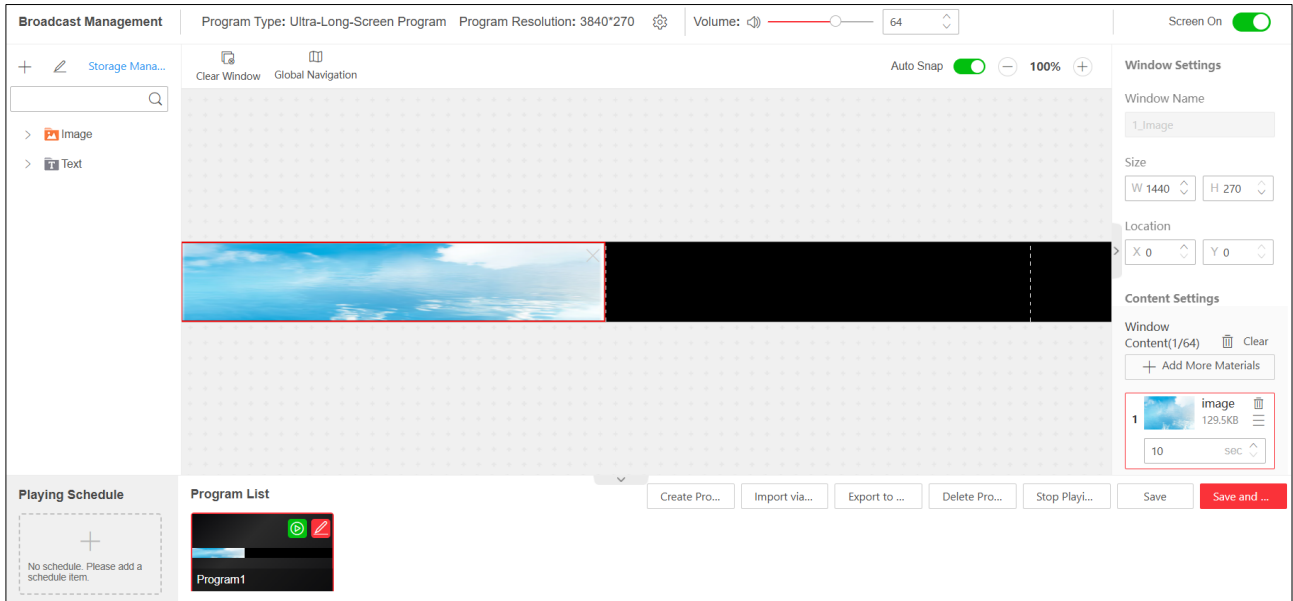

Figure 5-8 Release an Ultra-Long-Screen Program

5.1.3 Set Other Program Parameters

On the **Playing Control** page, you can perform the following operations as required:

- Click the program to add the background color, background image, or background music. The music must be in the MP3, WAV, or WMA format.

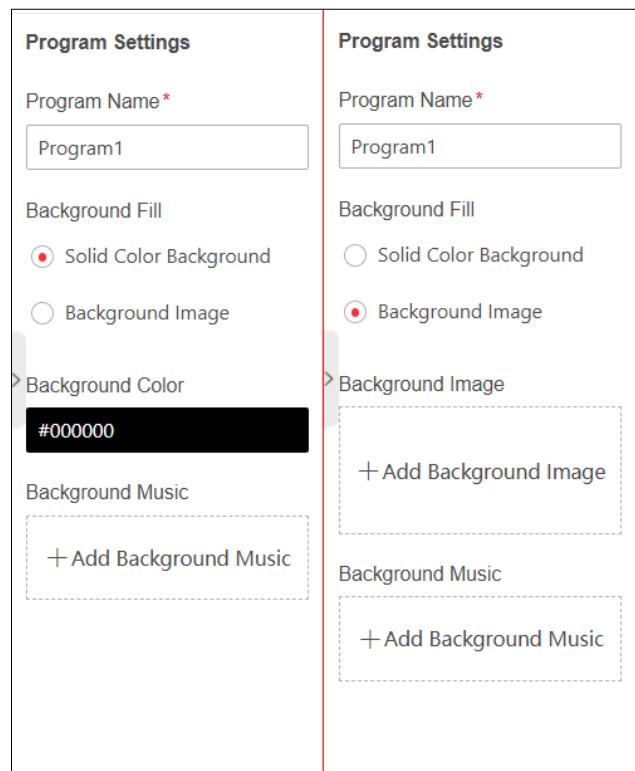

Figure 5-9 Add a Background

- Set the program status:
 - Click **Stop Playing**.
 - Click **Delete Program**.
 - Insert a USB flash drive into the device and click **Import via USB Flash Drive** to import the programs, materials and schedule in the USB flash drive to the device.
 - Insert a USB flash drive into the device and click **Export to USB Flash Drive** to export all programs, materials and schedule.
- Edit the volume.
- Edit the screen status:
 - If you enable **Screen On**, the screens exit the sleep mode.
 - If you do not enable **Screen On**, the screens enter the sleep mode.

5.2 Create and Play Multiple Programs

To play different programs at different times, you need to create multiple programs and create a schedule. The method for playing multiple normal programs or multiple ultra-long-screen programs is the same, and the following example uses normal programs.

Step 1 Create one program and save it. For details, see **5.1 Create and Play One Program**.

Step 2 Click **Create Program** and set the program parameters.

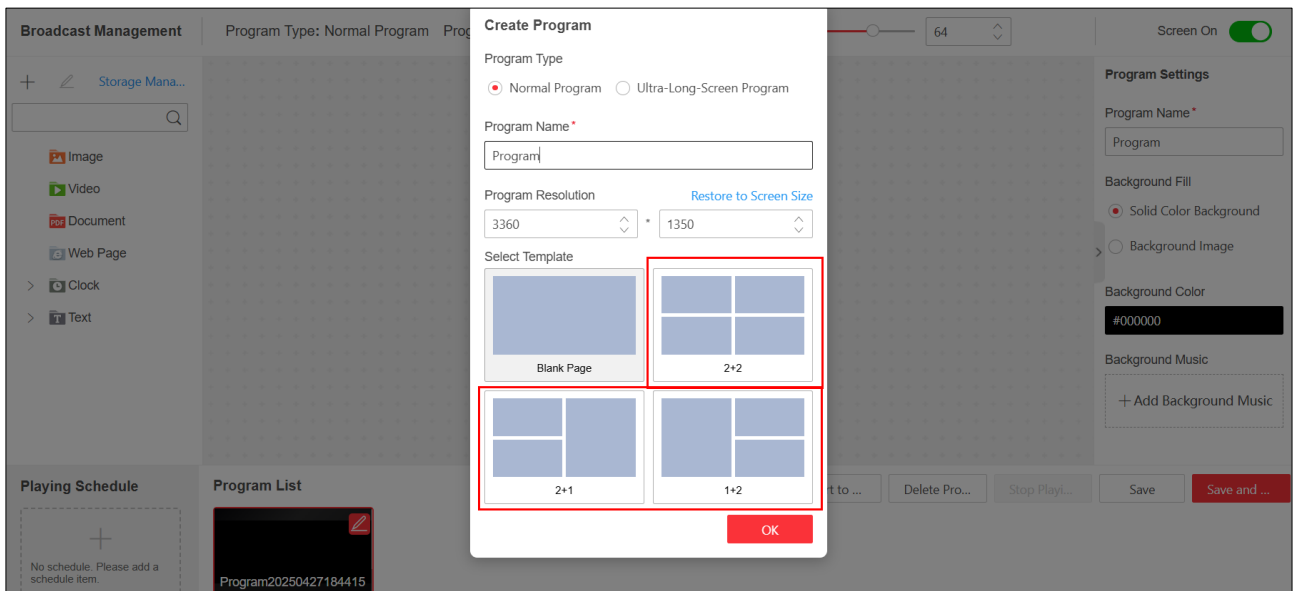

Figure 5-10 Create a New Normal Program

Step 3 Click  on the schedule area to create the schedule.

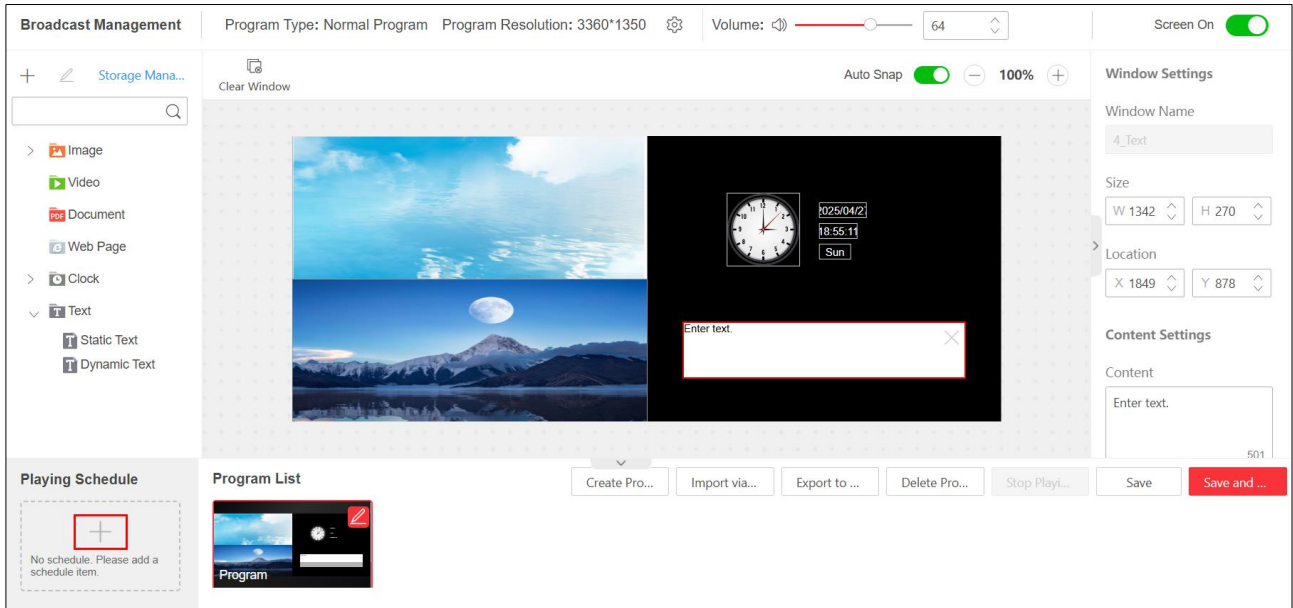

Figure 5-11 Create the Schedule

- Select **Auto-Switch**, drag programs to the playlist, and click **Save and Release**.
 - To clear all programs from the playlist, click **Clear**.
 - To save the auto-switch schedule without playing it immediately, click **Save**.

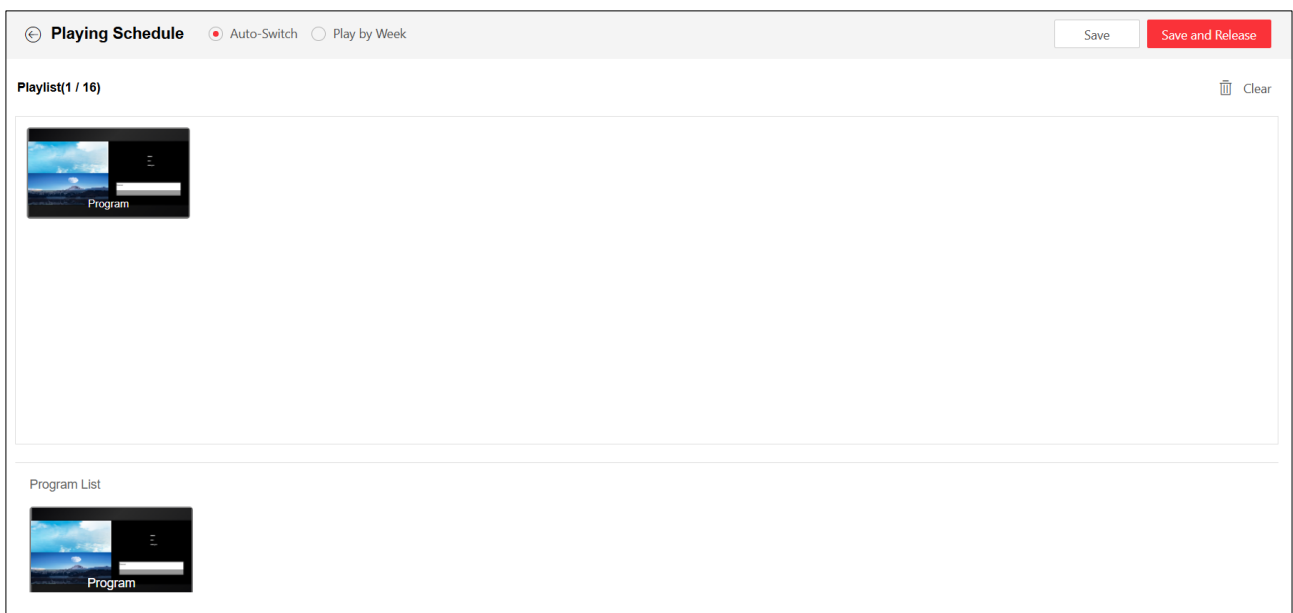

Figure 5-12 Set Auto-Switch Schedule

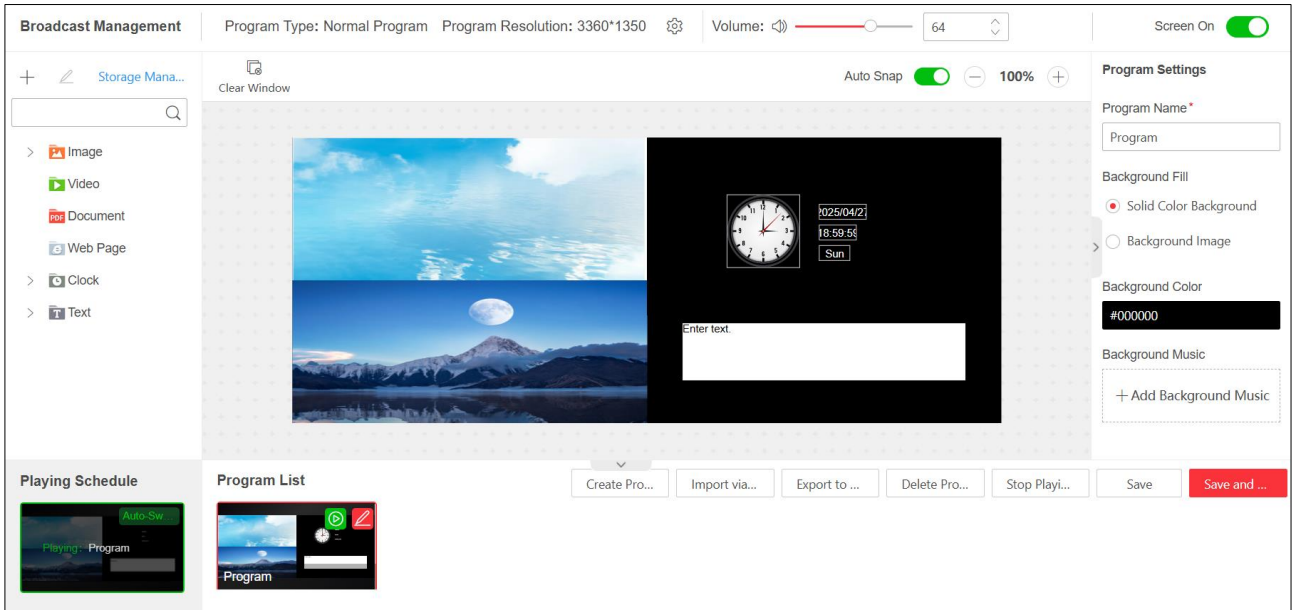

Figure 5-13 Auto Switch Normal Programs

- Select **Play by Week**, and set the programs and duration on the schedule.
- 1) On the schedule, left click the mouse to select the start time and hold the mouse to select the end time.
 - 2) Select a program and click **OK**.

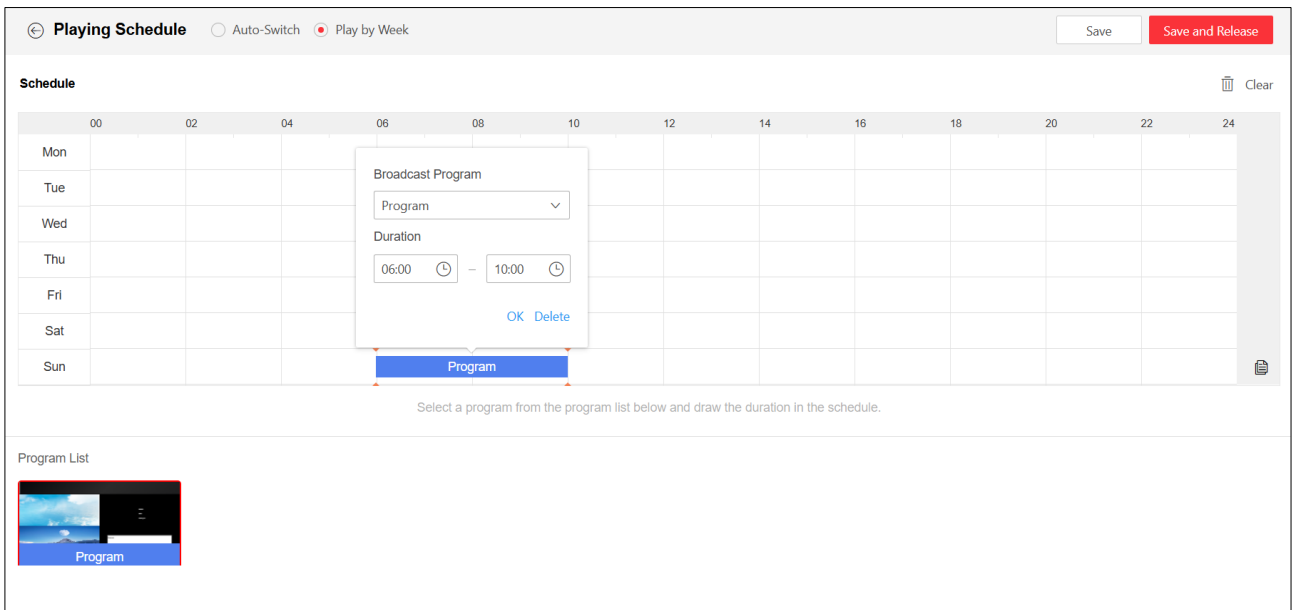



Figure 5-14 Configure the Schedule

- 3) Click **Save and Release**.
- 4) (Optional) You can perform the following operations as required:
 - Click **Delete** to delete the current schedule item.

- Click  to copy the current schedule item settings to the selected weekdays and weekends.
- Click **Clear** to clear all schedule items.

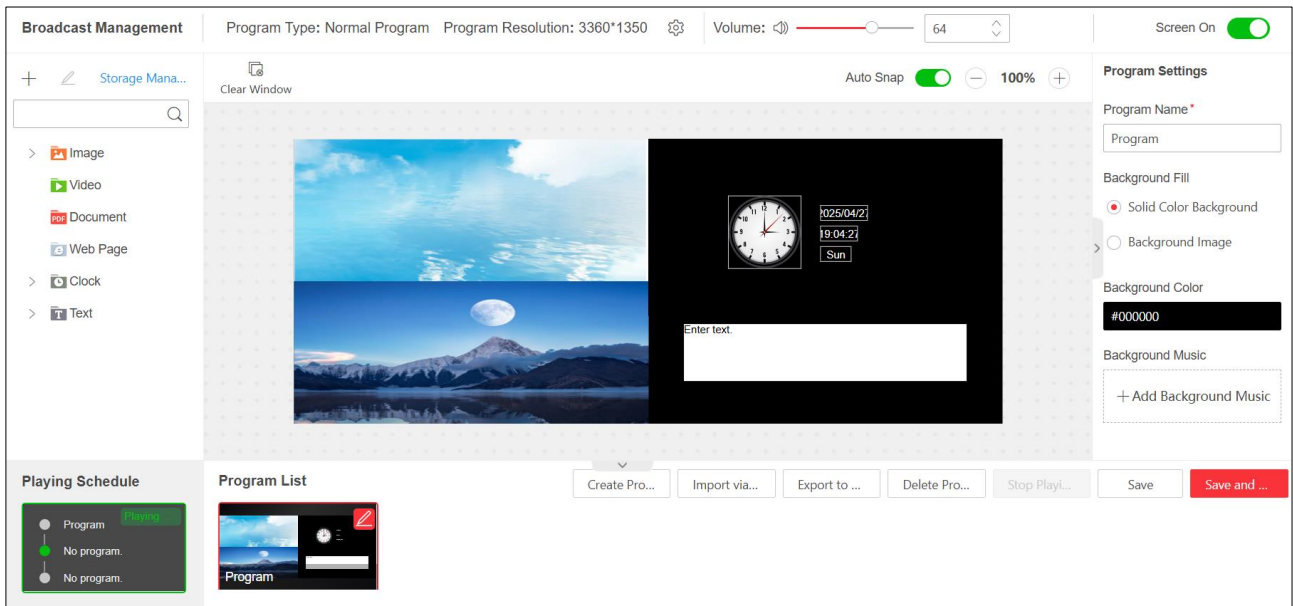





Figure 5-15 Play Normal Programs by Week

Step 4 (Optional) You can perform the following operations as required:

- Hover over the schedule and click  to edit the schedule.
- The program that is being edited is indicated by . To edit another program, hover over a program and click .
- Insert a USB flash drive into the device and click **Import via USB Flash Drive** to import the programs, materials and schedule in the USB flash drive to the device.
- Insert a USB flash drive into the device and click **Export to USB Flash Drive** to export all programs, materials and schedule.
- Insert a USB flash drive into the device, hover over a program that is not being edited, and then click  to export the program. You can enable auto program play after the insertion of USB flash drive.

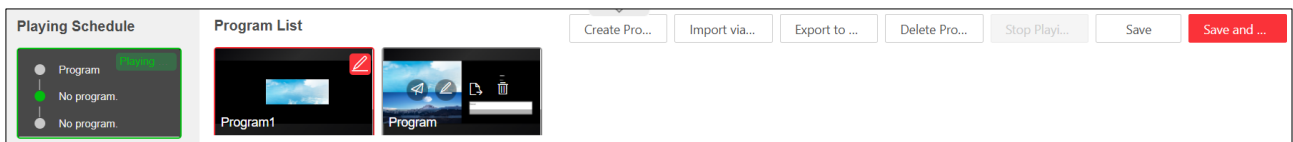



Figure 5-16 Export Single Normal Program

5.3 Manage Materials

Normal programs support image, video, document, web page, clock, and text materials, while the ultra-long-screen programs supports only image and text materials.

5.3.1 Configure Material Parameters

- For any type of material:
 - Adjust the window position: Select the material window and then hold the left mouse button to move the window directly or enter the position values.
 - Adjust the window size: Drag the material window edge or enter the width and height values to adjust the window size, or double click the material window to fully cover the program sub-window. Double click the material window again to restore the image window to its original size.
- For the image or video material:
 - Click and hold  to adjust the playing order of the image or video.
 - Click **Add More Materials** to upload the locally saved images or videos, or to select the images or videos from the material library.
 - Set an interval for each image. When multiple images are bound with the same program sub-window, the system automatically change the displayed image according to the set interval.
 - One program allows the audio tracks of only one video. The audio tracks of the first video bound with the program window is enabled by default. To use the audio tracks of another video, click a video and enable **Use Audio Tracks**.

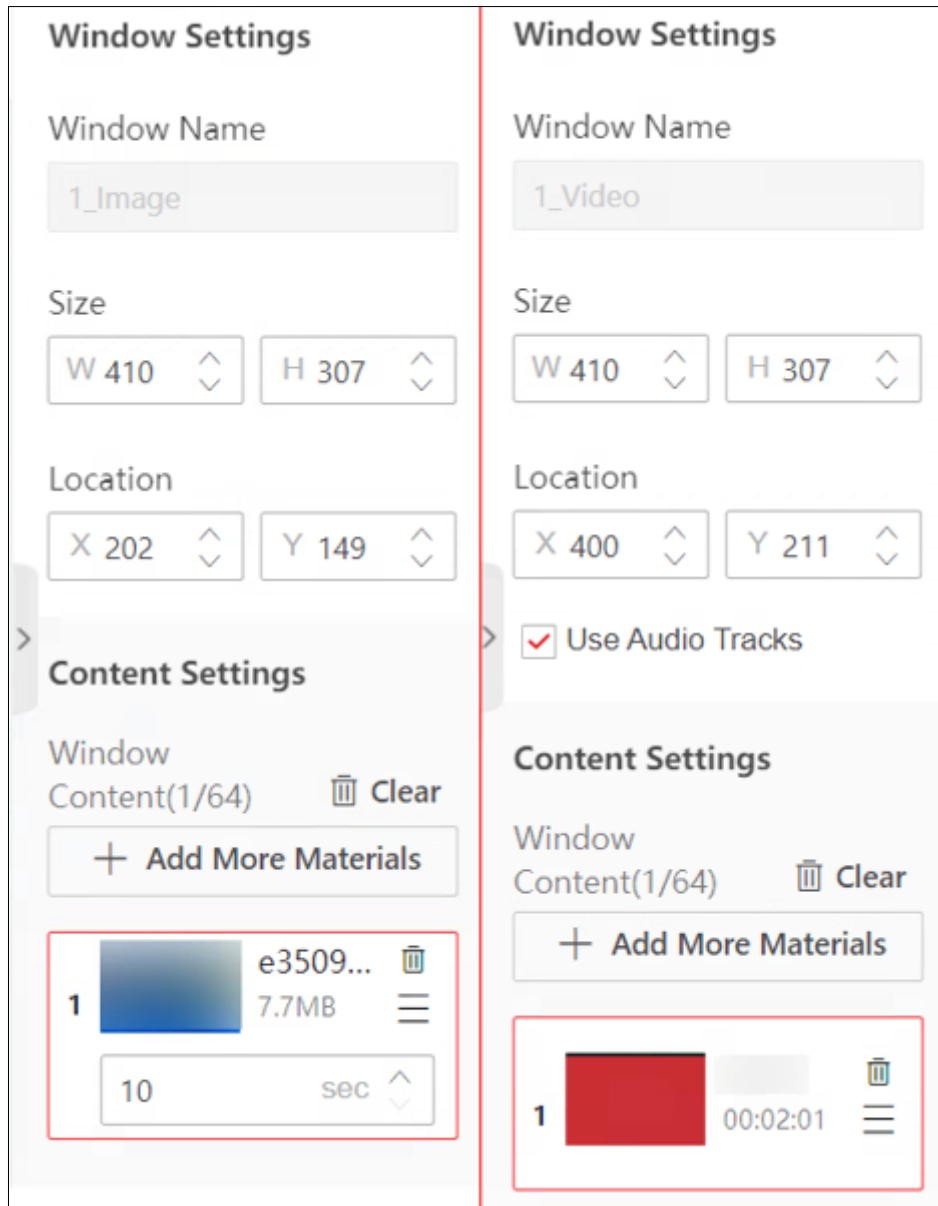



Figure 5-17 Configure Image/Video Material

- For the document material: Set a paging time.
- For the clock material:
 - Supports 7 types of clocks. One program allows only one clock.
 - The time are displayed by default. You can click  to hide the time.
 - Edit the clock template.
 - Edit the font size and color.
- For the text material:
 - Enter the content, select an existing font or a newly uploaded font, and set the font size, font color, alignment mode, background color, and background opacity.
 - For the dynamic text material, set the scrolling direction and speed.

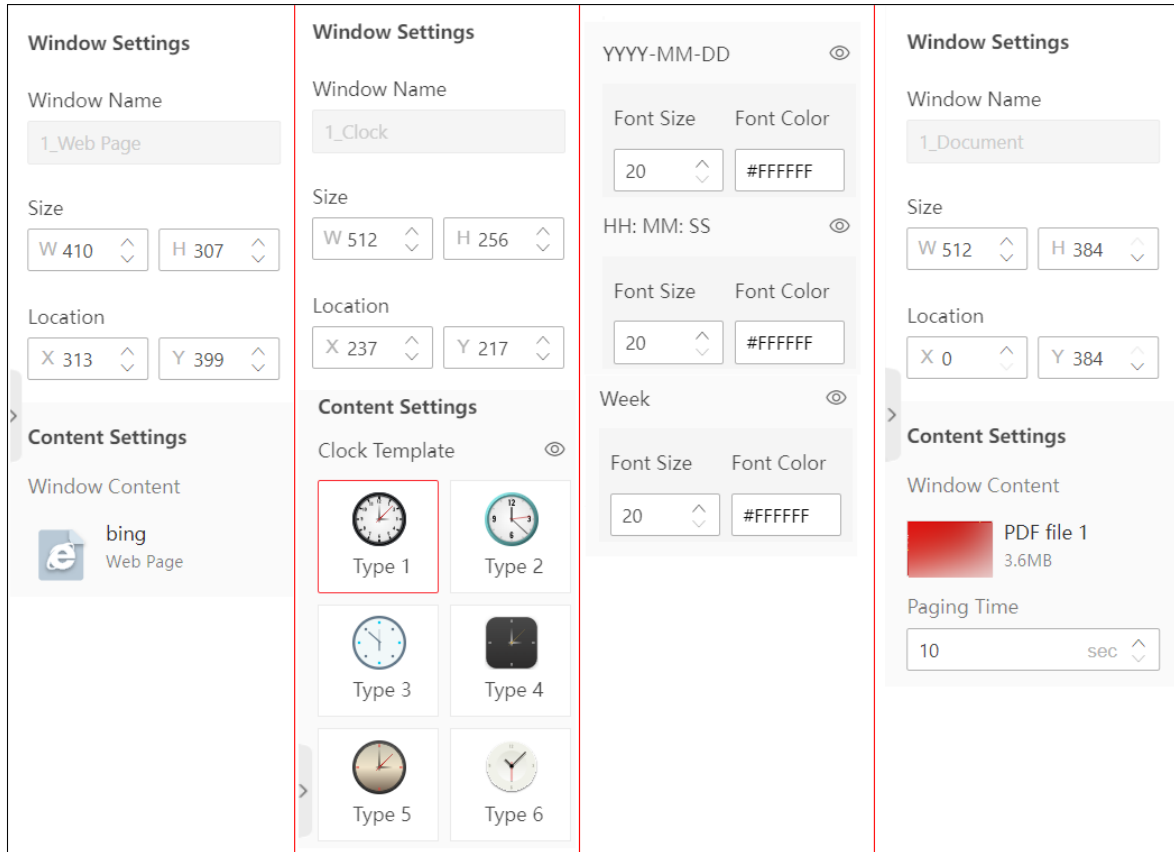

Figure 5-18 Configure Web/Clock/Document Material

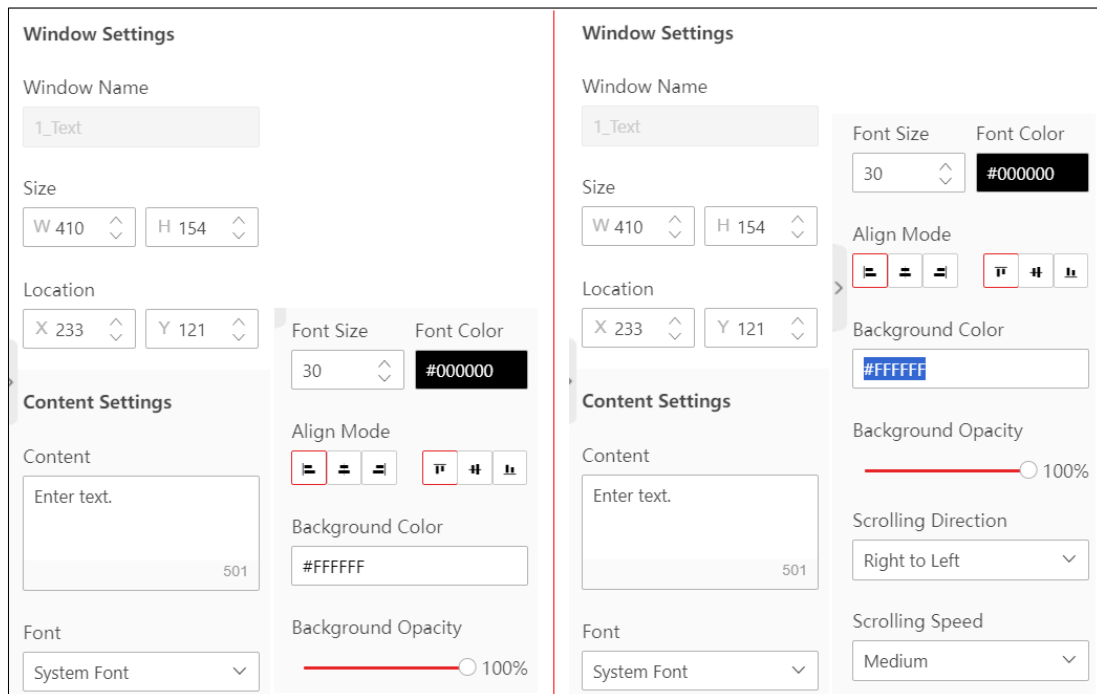

Figure 5-19 Configure Text Material

5.3.2 Delete Materials

Click **Storage Management** or Go to **Configuration** → **Storage Management** to go to the **Storage Management** page, select the unused materials and then click **Delete**.

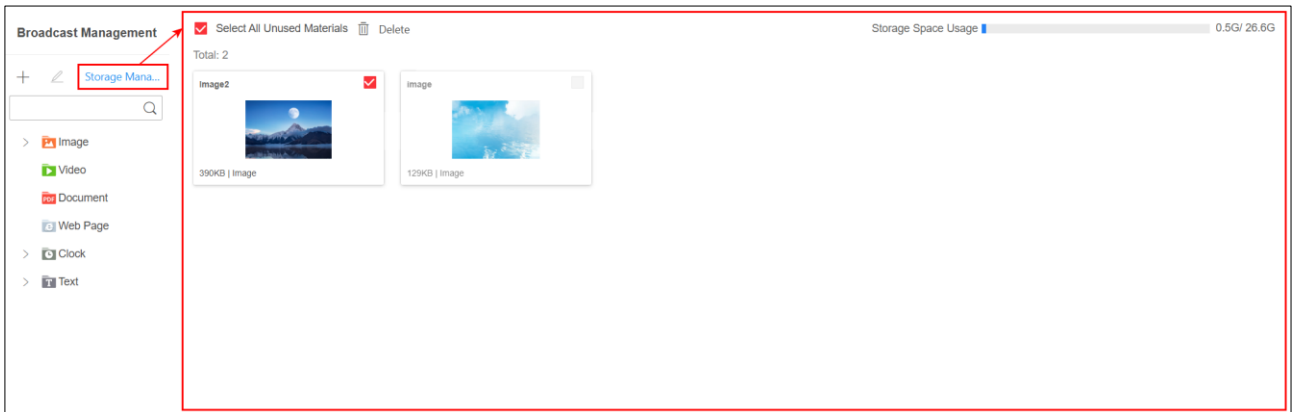

Figure 5-20 Storage Management Page

Chapter 6 Device Maintenance

6.1 View Device Status

Go to **Overview** or go to **Screen Maintenance** → **LED Controller Status** to view the detailed information of the device:

- Click a device to view its details, network port usage, and basic information.
 - You can identify the online and offline status of a receiving card: yellow indicates the offline status, and blue indicates the online status. Hover over a screen to view the resolution of an online receiving card.
 - Hover over a network port to view the network port usage.



Figure 6-1 View Status of the Device

- Click **Receiving Card Details** to view the receiving card details.

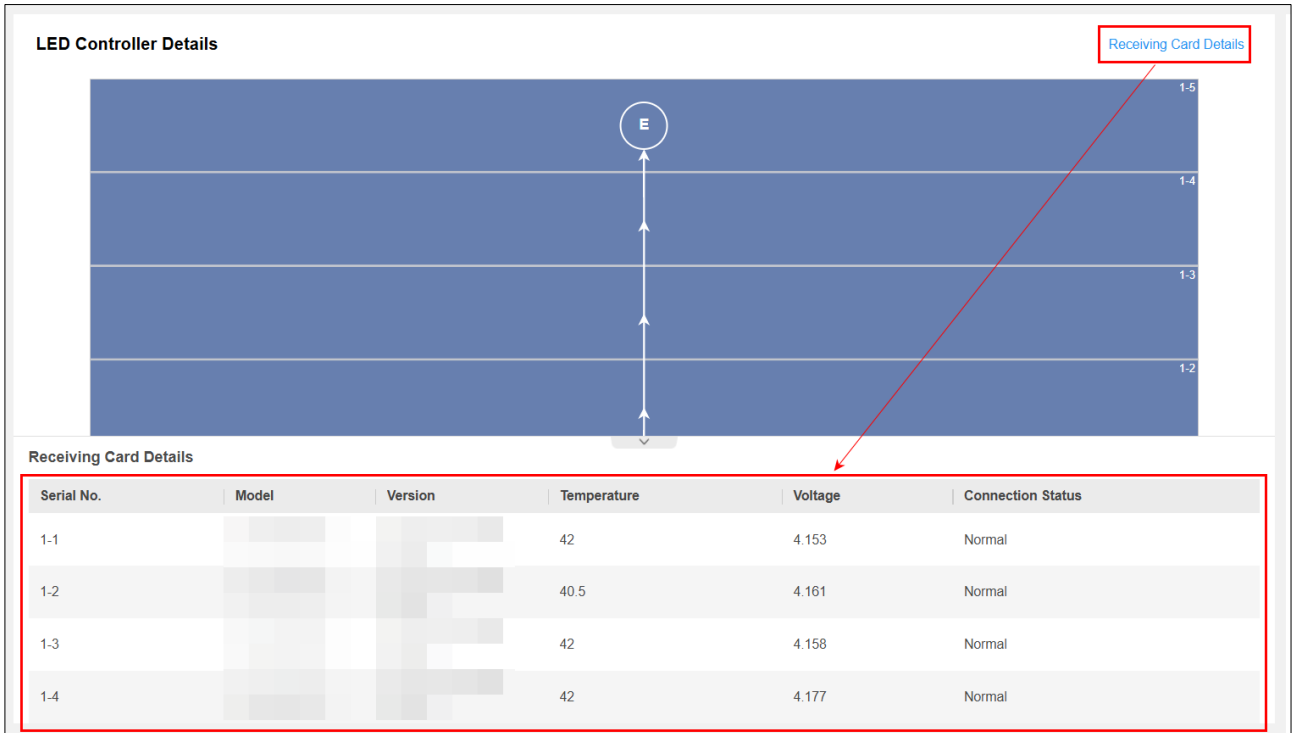

Figure 6-2 View Receiving Card Details

- Click **View Details** to go to **Configuration** → **System** → **Basic Information**.

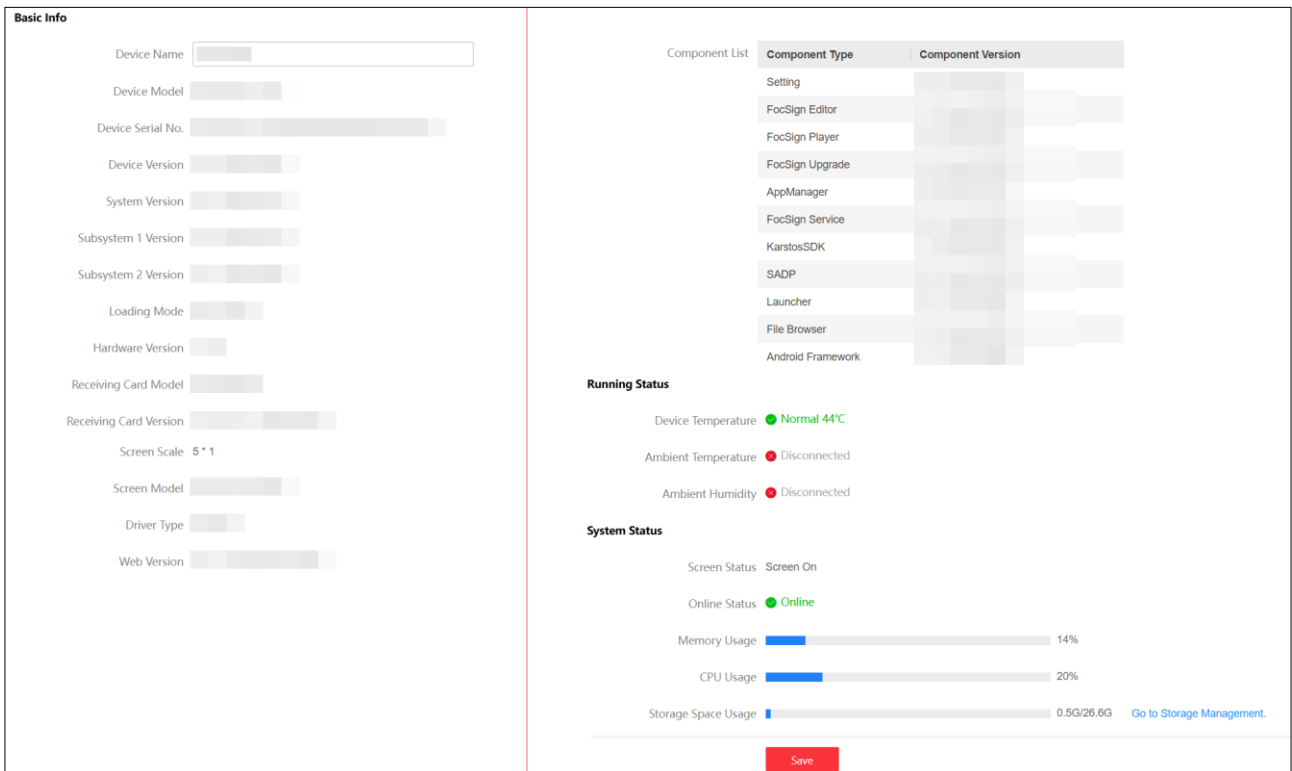

Figure 6-3 Basic Information of the Device

6.2 Quickly Maintain a Receiving Card

If the display is installed with a new receiving card, you can use this function to copy the configuration of the reference receiving card to the new receiving card. Make sure the newly installed receiving card is connected with the LED controller.

Step 1 Go to **Maintenance and Security** → **Receiving Card Quick Maintenance**.

Step 2 Select a receiving card and click **Set as Reference Card**. The configuration of the reference receiving card can be copied to the new receiving card.

Step 3 Select a receiving card and click **Set as New Card**.

Step 4 Click **Copy** to copy the configuration file of the reference card to the new card.

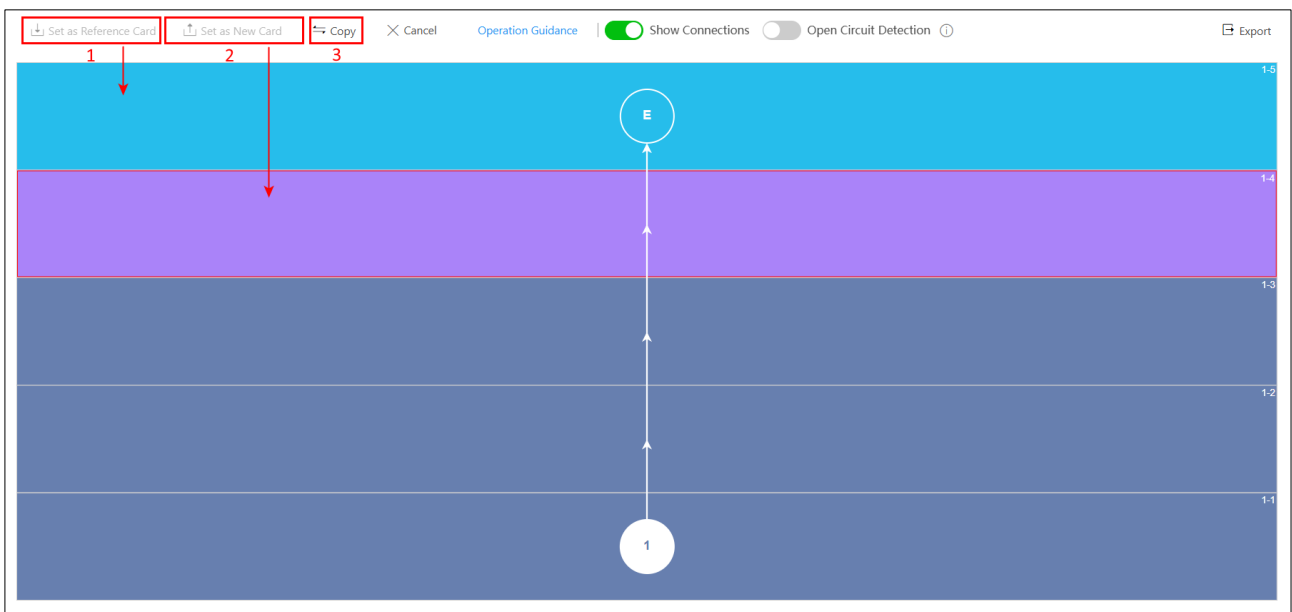

Figure 6-4 Quickly Maintain Receiving Cards

Step 5 (Optional) You can perform the following operations as required:

- Click **Export** to export the receiving card program file or receiving card configuration file.

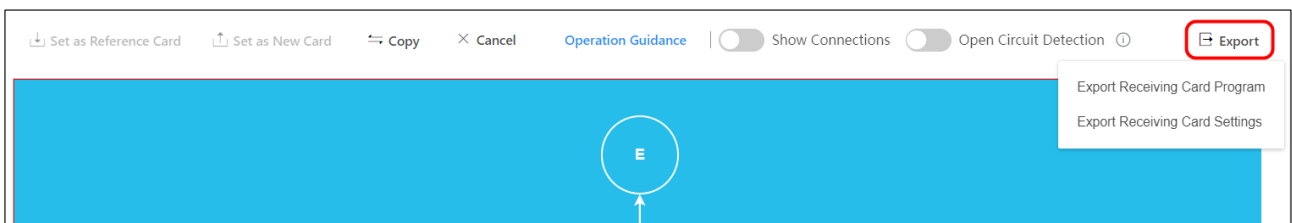

Figure 6-5 Export Receiving Card Parameters

- Click **Show Connections** to view the signal connection of the LED controller.
- Enable **Open Circuit Detection** to repair the cross phenomenon caused by damaged lamp beads. Before repairing the damaged lamp beads, disable open circuit detection.
- Click **Cancel** to cancel the copy operation.

6.3 Test Screen Condition

Use the color bars and waves to check whether the screen color is normal or whether the dead pixels exist.

Step 1 Go to **Maintenance and Security** → **Screen Test**.

Step 2 Enable the screen test.

Step 3 Select a pure color, gray scale, or line to check whether the screen color is normal or whether the dead pixels exist.

If the existing color does not meet the requirements, add a new color. You can edit or delete the newly added color.

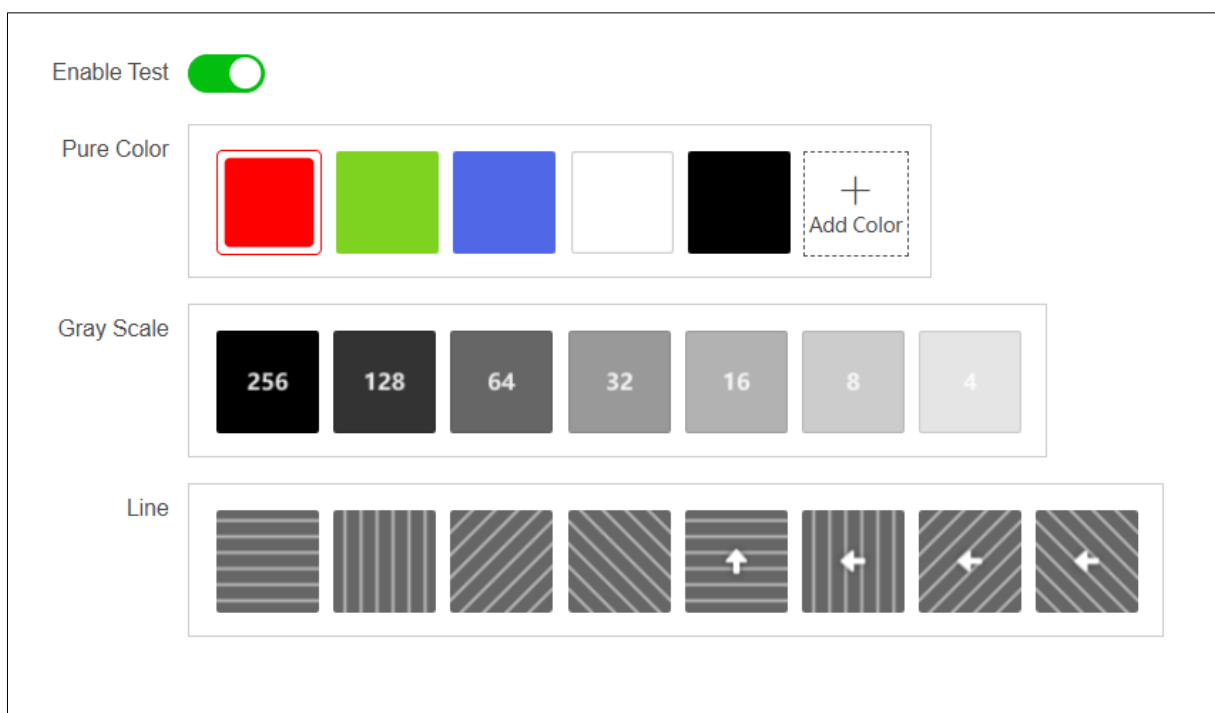



Figure 6-6 Test Screen Condition

6.4 Maintain the System

Go to **Maintenance and Security** → **System Maintenance** to perform the following operations as required:

- On the **Restart** page, restart the LED controller or receiving card.
- On the **Upgrade** page, click  to select a locally saved upgrade package and click **Upgrade**.
 - Do not power off the device during the upgrade process.
 - If the device cannot run normally due to the upgrade failure, contact the supplier timely.
 - After the upgrade process is complete, the device restarts automatically.

- On the **Backup and Reset** page, export the configuration file of the LED controller or receiving card.
- On the **Backup and Reset** page, reset the device:
 - Click **Restore Default** to restore the display effect and receiving card parameters to the factory settings. Please use this function with caution.
 - Click **Restore Factory** to restore all functions and parameters to the factory settings. Please use this function with caution.
 - Click  to select a locally saved configuration file and click **Upload**.

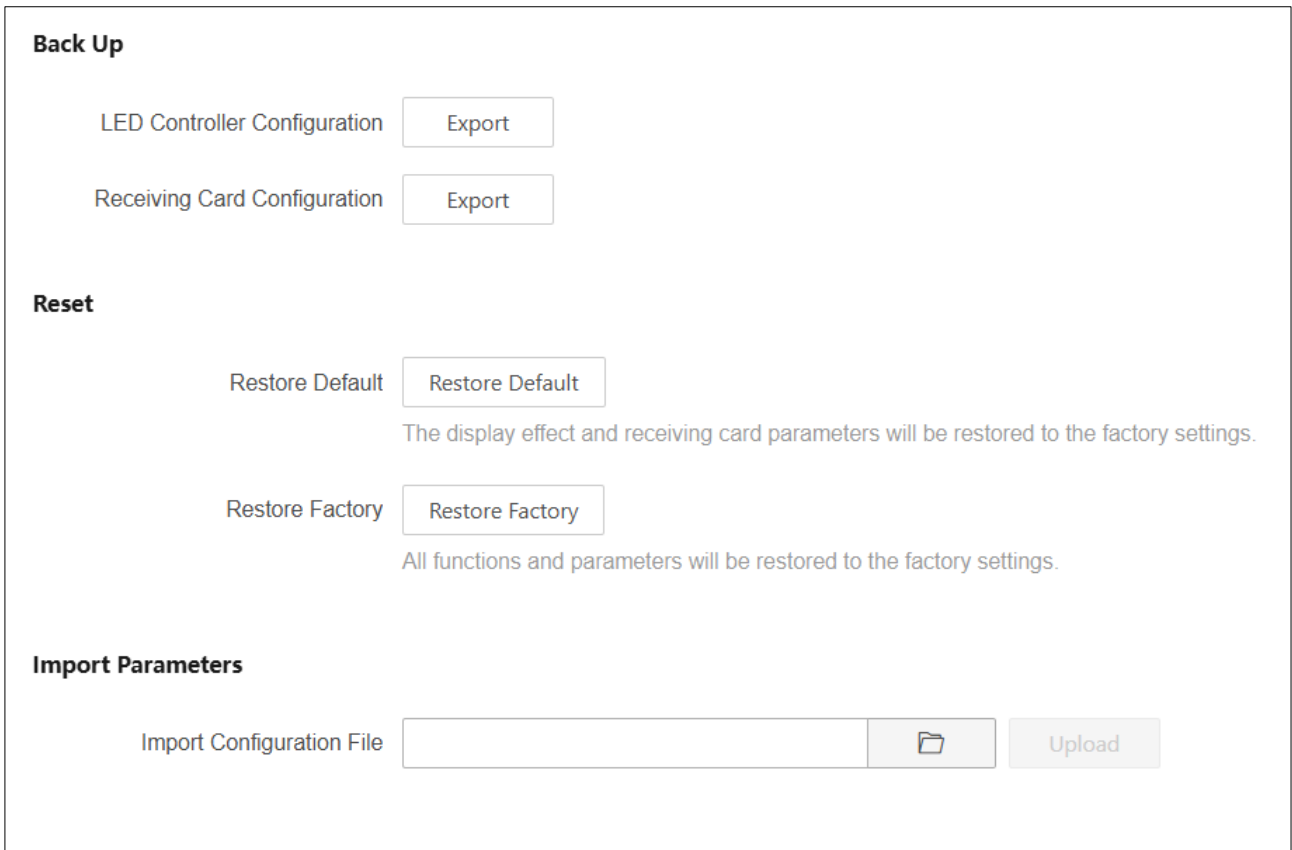

Back Up

LED Controller Configuration

Receiving Card Configuration

Reset

Restore Default
The display effect and receiving card parameters will be restored to the factory settings.

Restore Factory
All functions and parameters will be restored to the factory settings.

Import Parameters

Import Configuration File

Figure 6-7 Back Up and Reset Device

- On the **Log** page, set the search condition and click **Search**. You can view the searched logs in the list below. You can click **Export** to export the logs.

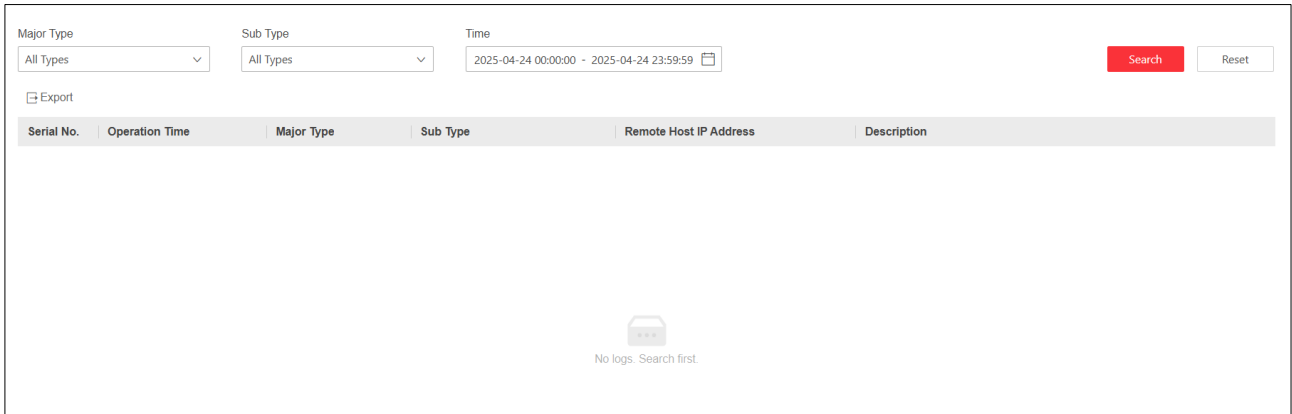

Figure 6-8 Search Logs

- On the **Device Debugging** page, enable the following functions as required:
 - If the device supporting dual power supply is installed with two power supplies, you can enable **Dual Power Supply**. When one power supply fails, you can view the relevant prompt on the device web page.
 - Enable **Log Records** to record the maintenance logs of the Android system.
 - Click **Export** to export the ZIP file of the Android system maintenance logs.
 - Enable **ADB Debugging**, and then use the Android Debug Bridge (ADB) tool and the device activation password to maintain the device Android system.

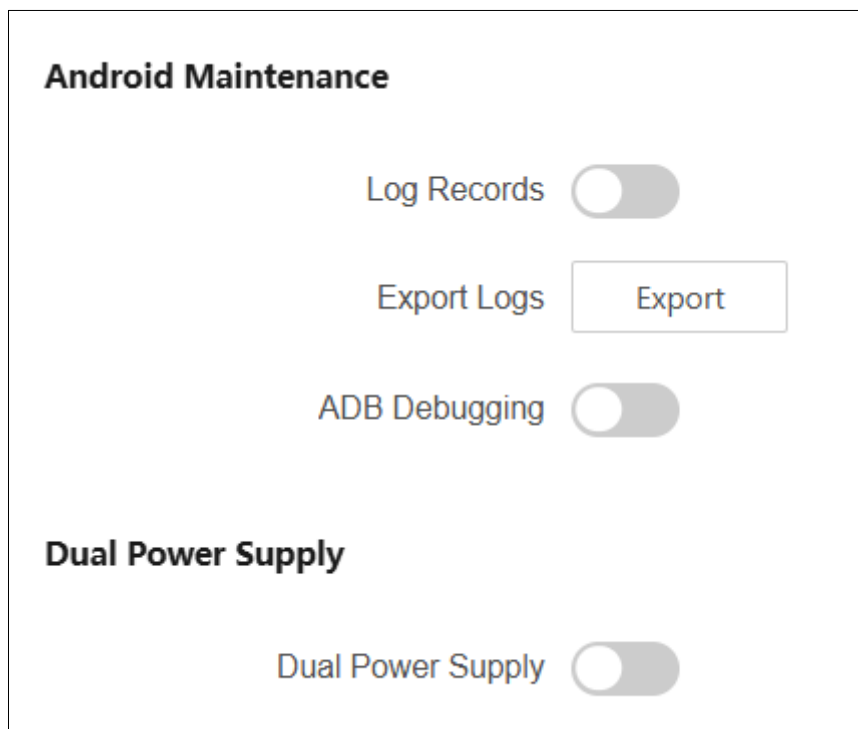

Figure 6-9 Debugging the Device

- On the **Permission Management** page, turn on or off the screen controlled by the device:
 - 1) Enable **Screen-Off**.

- 2) Select a screen-off method.
- 3) Set the screen-on code. When the screen is turned off, you can go to the **Permission Management** page and enter the screen-on code to turn on the screens.

The image shows two side-by-side screenshots of a web interface for managing screen-off settings. Both screenshots feature a red 'Save' button at the bottom.

Left Screenshot (Immediate Screen-Off):
- 'Screen-Off' toggle is turned on (green).
- 'Screen-Off Method' has 'Immediate Screen-Off' selected with a red radio button, and 'Scheduled Screen-Off' is unselected.
- '*Set Screen-On Code' is a text input field with a lock icon and a visibility toggle icon.

Right Screenshot (Scheduled Screen-Off):
- 'Screen-Off' toggle is turned on (green).
- 'Screen-Off Method' has 'Scheduled Screen-Off' selected with a red radio button, and 'Immediate Screen-Off' is unselected.
- '*Scheduled Screen-Off Time' is a date-time picker field showing '1970/01/07 09:47:17' with a calendar icon.
- '*Set Screen-On Code' is a text input field with a lock icon and a visibility toggle icon.

Figure 6-10 Permission Management Page

Chapter 7 Screen Configuration (Other Pages)

7.1 Use the OSD Page

Before You Start

Make sure that you have lightened the display. For details, see “**3.2 Lighten the Device**”.

Steps

Step 1 Select a remote control and connect the selected remote control to the device.

- Insert the USB plug of RF remote control into the USB port of the device. The valid distance between RF remote control and device is about 15 m within 45° angle in the left and right.
- Insert the 3.5 mm plug of IR remote control into the IR IN port of the device. The valid distance between IR remote control and device is about 10 m within 45° angle in the left and right.

Step 2 Use the remote control to operate the OSD page of the device.

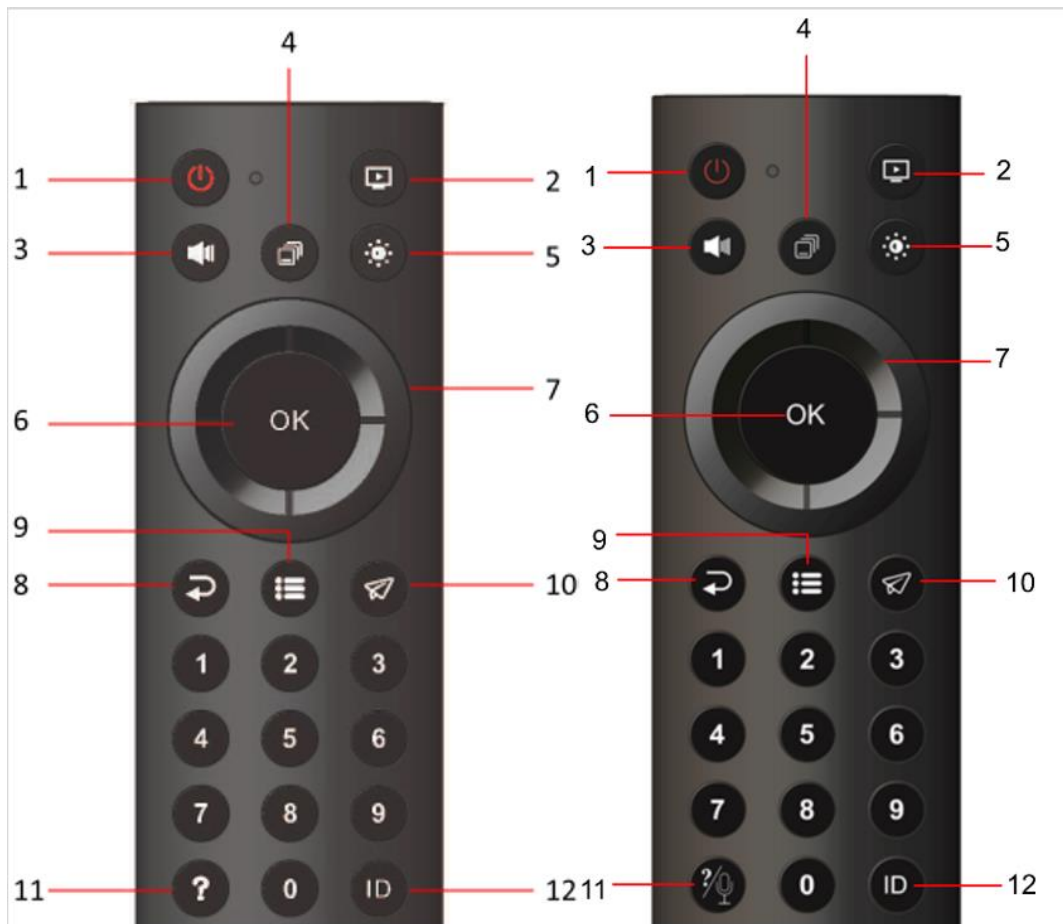



Figure 7-1 IR Remote Control (Left) and RF Remote Control (Right)

Table 7-1 Remote Control Button Description

No.	Name	Description
1	Power	<ul style="list-style-type: none"> ● If the display is on, pressing the button will make the display enter sleep mode. ● If the display is in sleep mode, pressing the button will wake up the display.
2	Signal source switchover	Press the button to call out the signal source channel page. Use the left and right direction buttons to switch the signal source channel, and press OK to confirm the channel selection.
3	Volume	Press the button to call out the volume adjustment page. Use the left and right buttons to adjust the volume.
4	Shortcut menu	<p>Press the button to enter the shortcut menu page.</p> <ul style="list-style-type: none"> ● After selecting System Info, you can view the LED controller information, receiving card information, and system monitoring information. ● After selecting Source Info, you can press the button to call out the signal source information page to view the detailed signal source information. ● After selecting Choose Scene, you can press the button to call out the scene switching page. Use the up and down direction buttons to switch scenes, and press OK to confirm the scene selection. ● After selecting Open Dehum, you can enter the dehumidification page. Use the left and right direction buttons to enable or disable the immediate dehumidification function. ● After selecting Best EDID, you can press OK to enable BEST EDID, and press OK again to disable it.
5	Brightness adjustment	Press the button to call out the brightness adjustment page. Use the left and right direction buttons to adjust the brightness.
6	OK	Confirm the current configuration.
7	Direction	Control the upper, lower, left and right directions.
8	Exit	Exit the current page.
9	Menu	<p>Enter the main menu page.</p> <p>On the main menu page, you can configure input, output, display, and color parameters.</p>
10	Back	Return to the main menu page.

No.	Name	Description
11	Help	<p>Press the button to call out the remote control help instruction.</p> <p> Note</p> <p>Voice control is not supported.</p>
12	ID	<ul style="list-style-type: none">• Press the button to show the device ID.• Press the button to show the device ID and enter the ID of the device you want to control. Ensure that you have enabled Sending Card Network Cascade on the LED Settings → System Configuration → Sending Card Network Cascade page of the LED batch controller client.

7.2 Use GUI Page

7.2.1 GUI Page Overview

Step 1 Connect the mouse and keyboard to the USB ports of the device.

Step 2 Lighten the display connected to a P device. For details, see “**3.2.2 Lighten the Screen**”.

Step 3 The FocSign Player page shows on the lightened display.

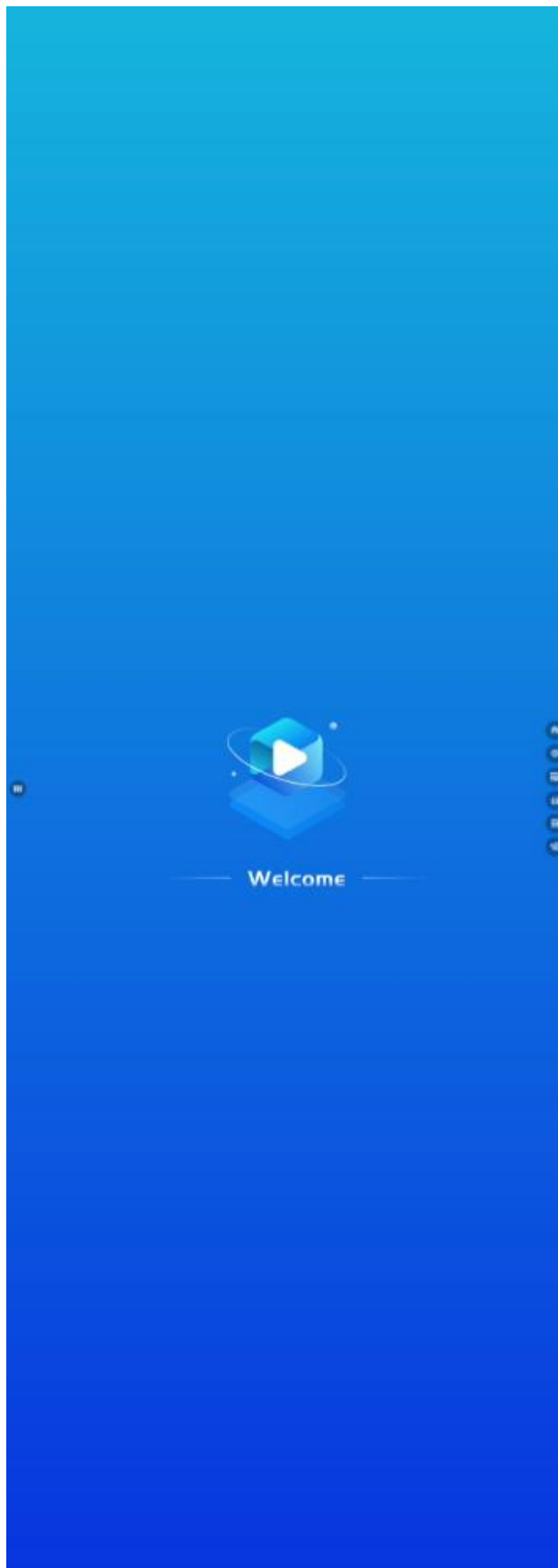





Figure 7-2 FocSign Player Page

- Click  to enter the main page.
 - Click **Setting** or click  in the lower right corner of the main page to enter the **Setting** page.
 - Click FocSign Player to enter the FocSign Player page.
 - Click  to view the notifications.
 - Right click the mouse to exit the current application or current page.

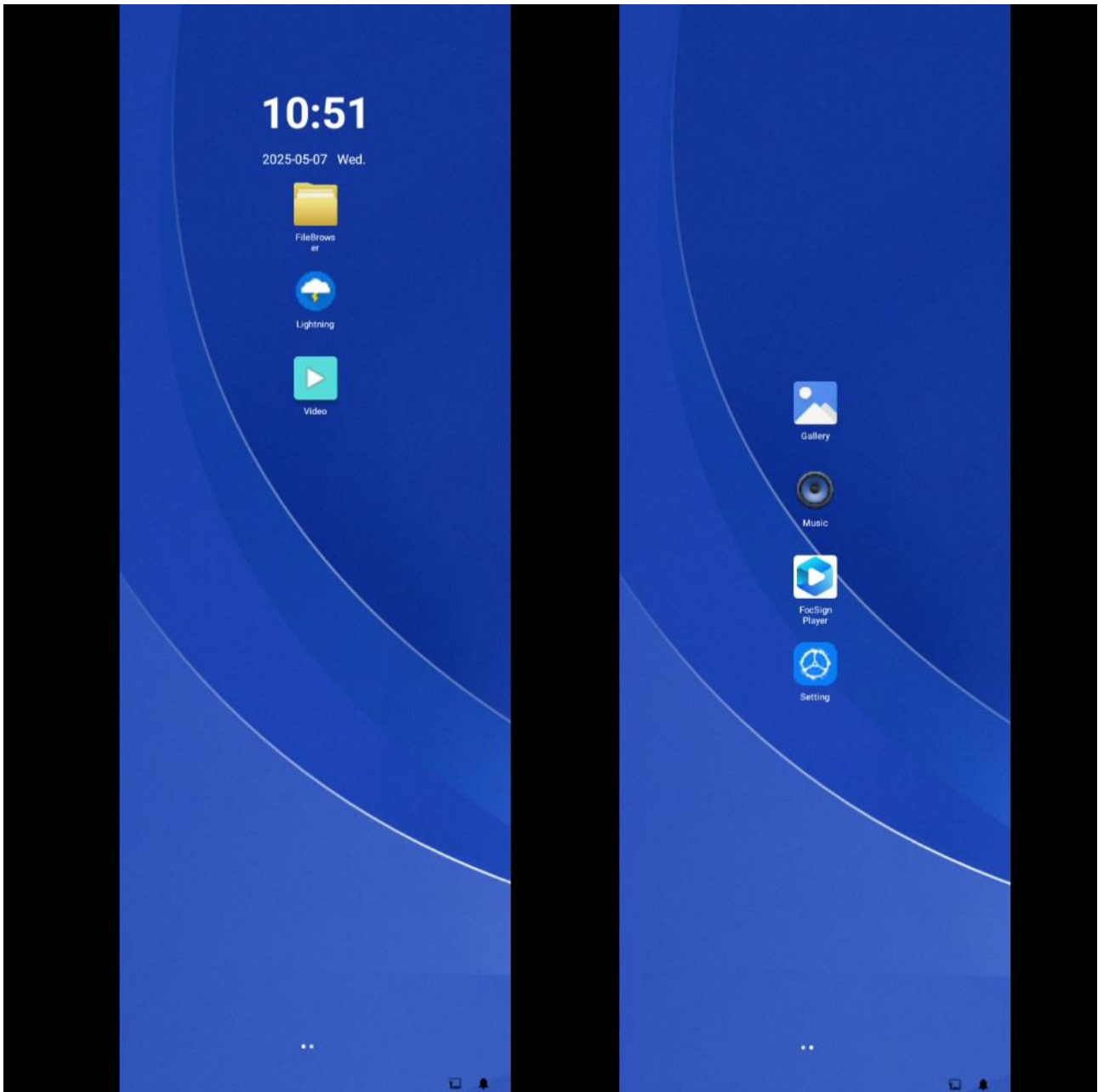



Figure 7-3 GUI Main Page

- Click  to open the **System Settings** window. You can set the terminal information and screen lock.

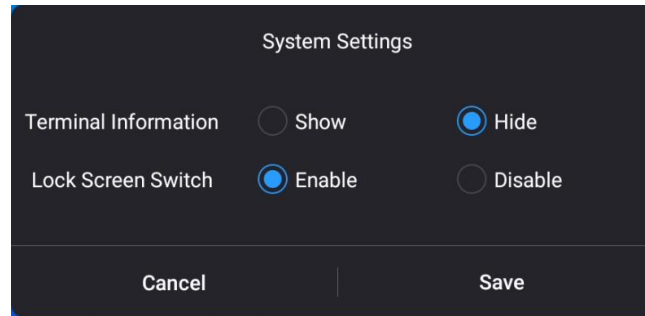







Figure 7-4 System Settings Window

- Click  to open the **Server Settings** Page. This function is not available.
- Click  to enable screen lock and click  to lock the screen. After the screen is locked, you need to enter the device activation password to unlock the screen.
- Click  to open the **Basic Information** page to view the basic information of the device.
- Click  to enter the **Playing Schedule** page.

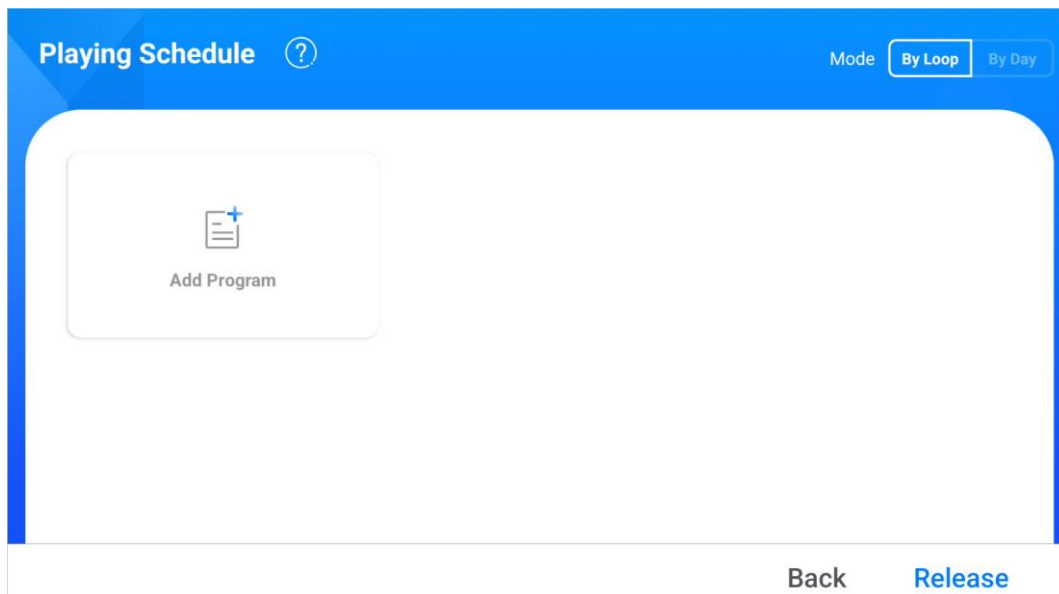

Figure 7-5 Playing Schedule Page

7.2.2 Splice Screens on GUI Page

Step 1 On the FocSign Player page, click  to enter the **Splice Screen** page.

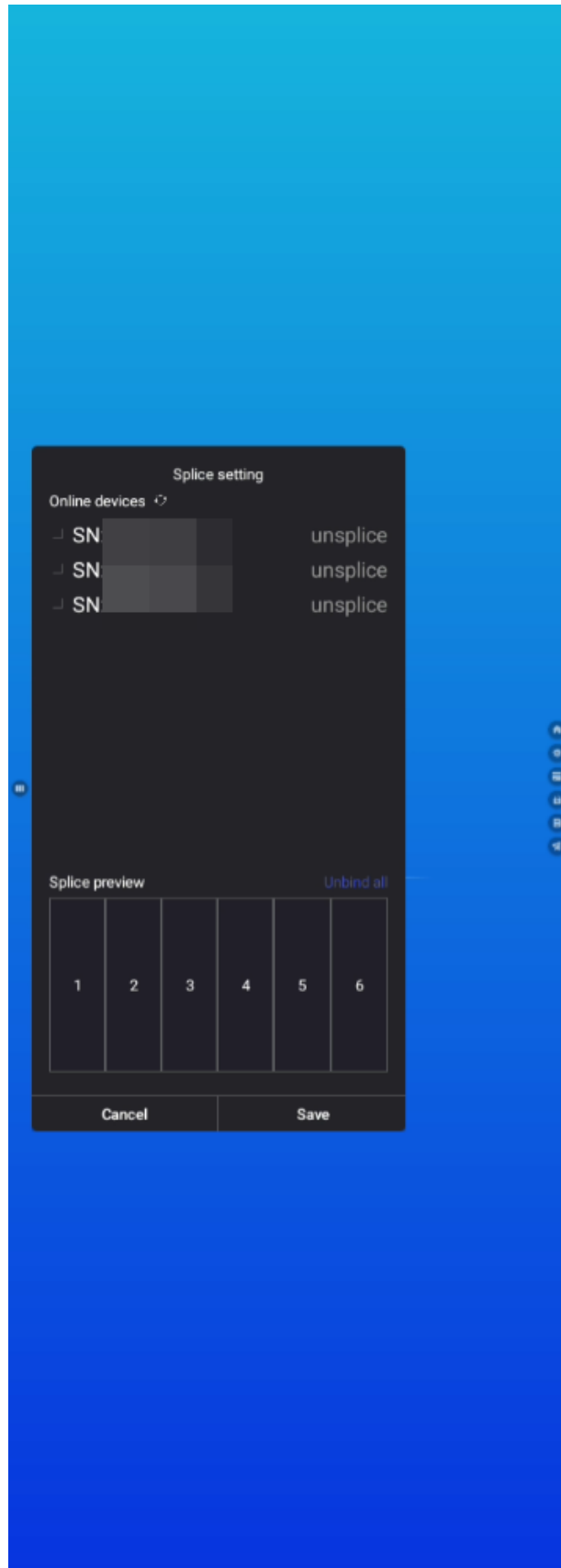

Figure 7-6 Splicing Screen Page

Step 2 Select the online devices that need to be spliced. Click **Save**.

 **Note**

When selecting, the order of selecting the device serial numbers must correspond to the sequence of their corresponding screens in splicing positions. For example, tick the serial number of the first device and then tick the serial number of the second device.



Figure 7-7 Select the Screens to be Spliced

Step 3 The screens are successfully spliced.

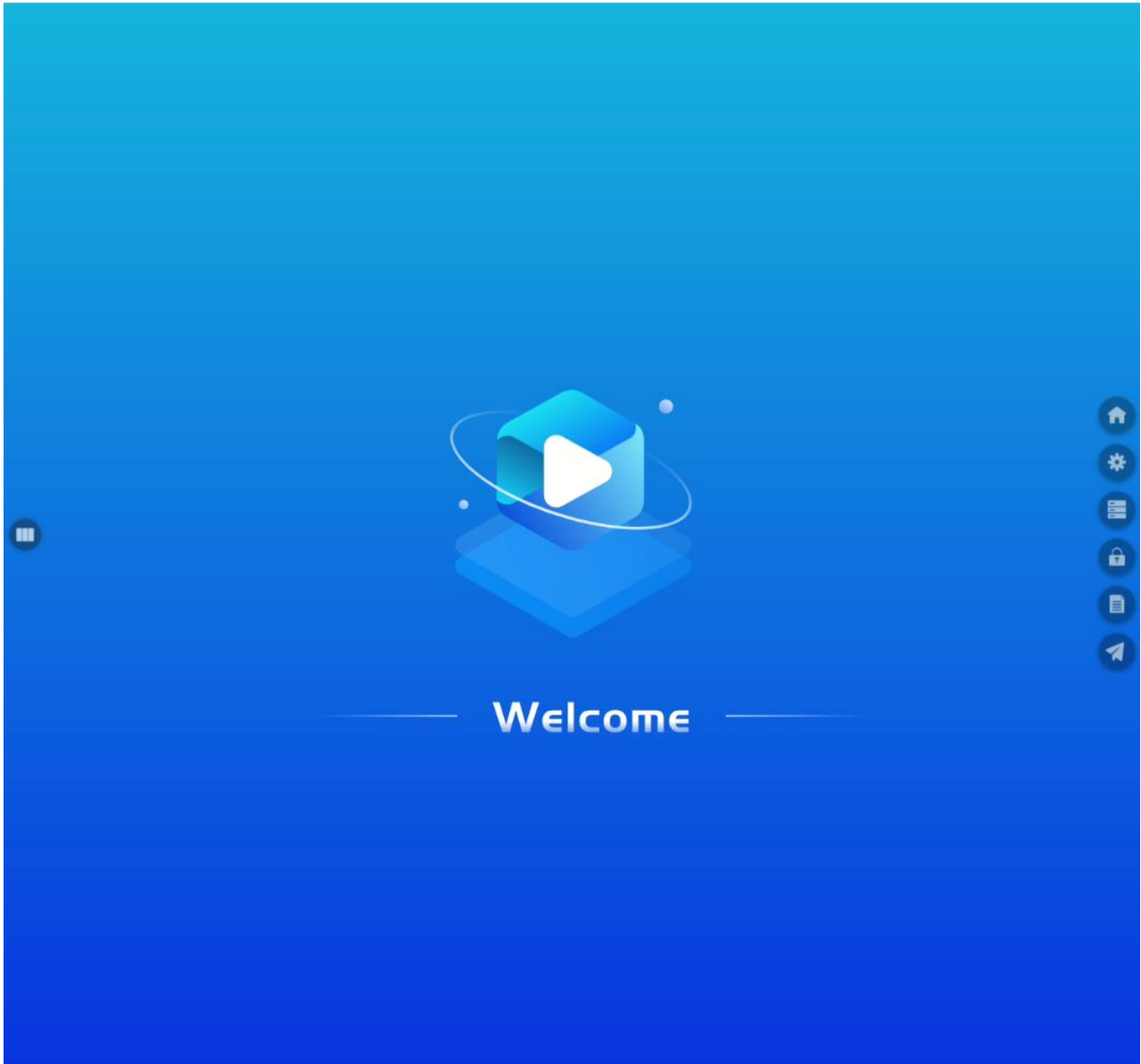



Figure 7-8 Screens Spliced

Step 4 (Optional) Click  to see the splicing status of the screens.

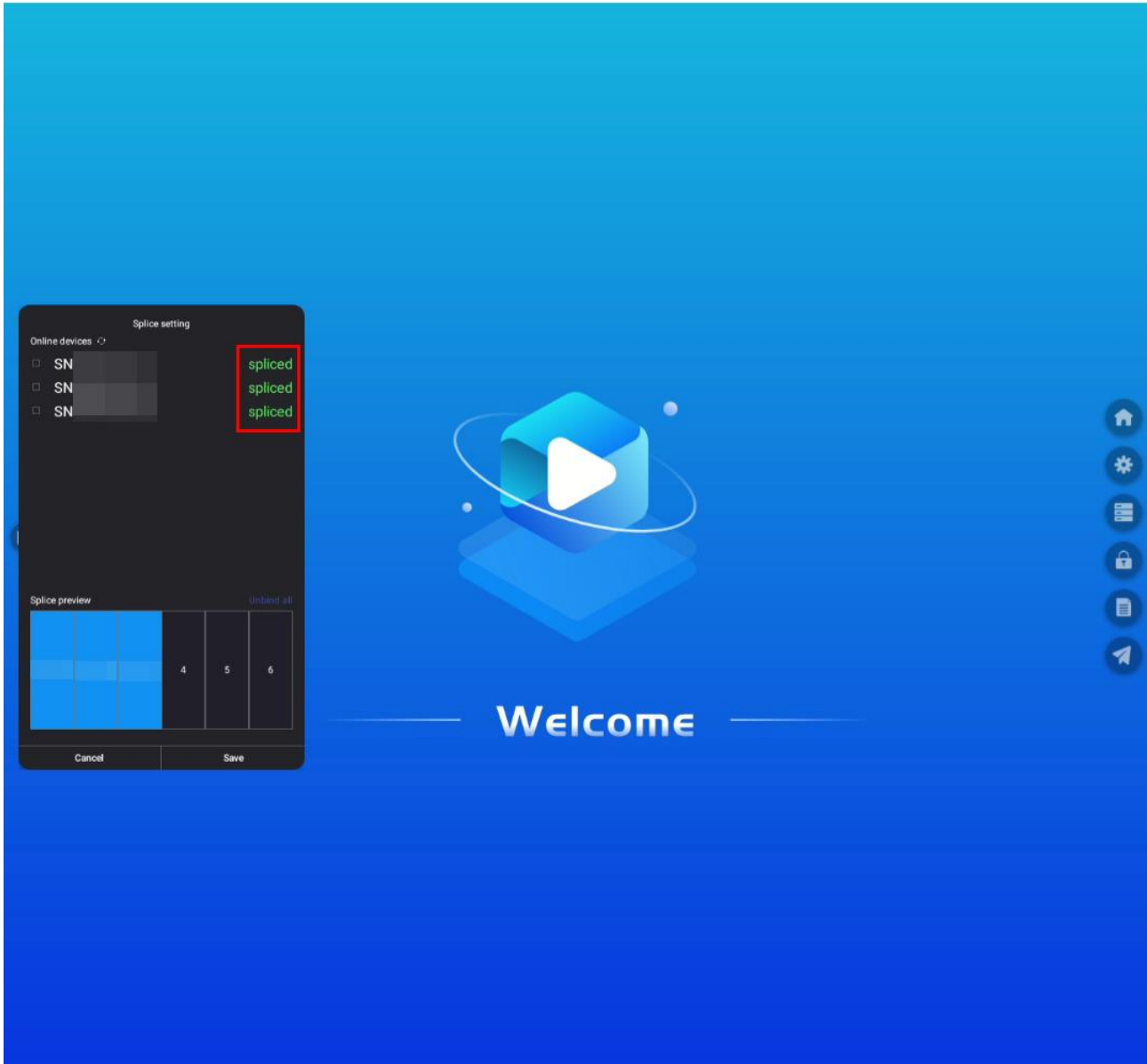

Figure 7-9 View Splicing Status

Step 5 (Optional) If you need to cancel the splicing of spliced screens, click **Unbind All**, and click **Save**. All the spliced screens are unbounded.

 **Note**

If the device is in spliced status, you can also directly click **Save** to unbind.

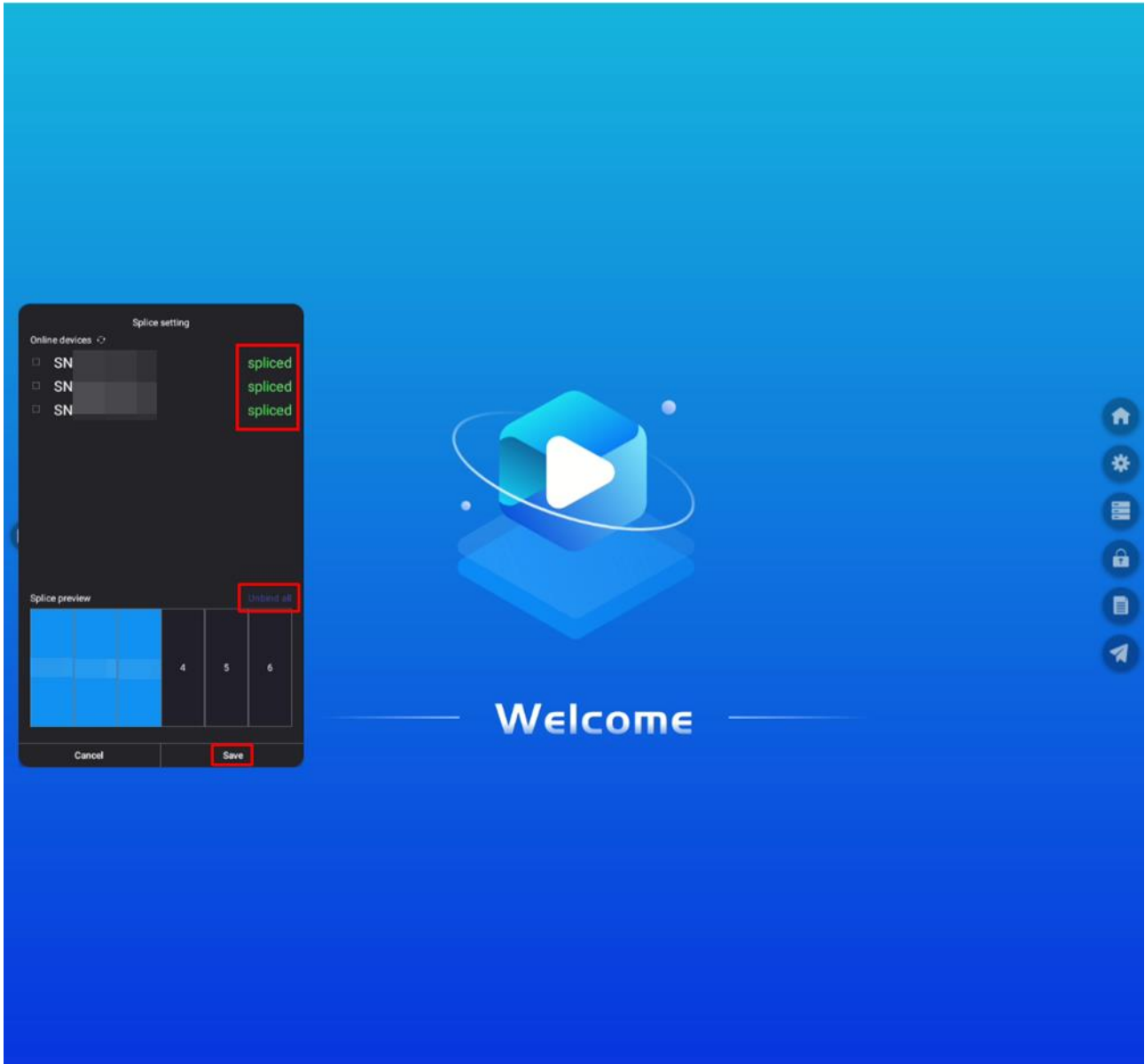

Figure 7-10 Unbind the Spliced Screens

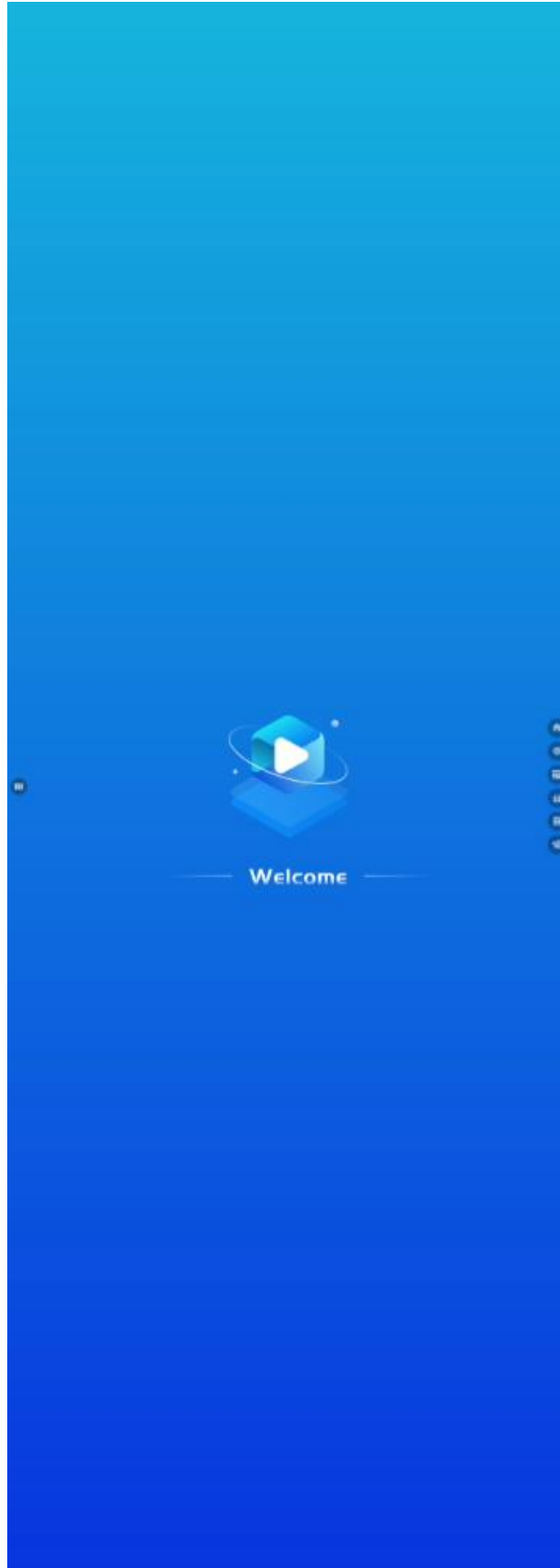

Figure 7-11 Spliced Screens Unbounded

7.2.3 Set Playing Schedule

Step 1 On the FocSign Player page, click  to enter the **Playing Schedule** page.

Step 2 Select a mode:

- If you select **By Loop**, click **Add Program**, and select a template.
- If you select **By Day**, click **Add Time Period Program**, and select a time period and a template.

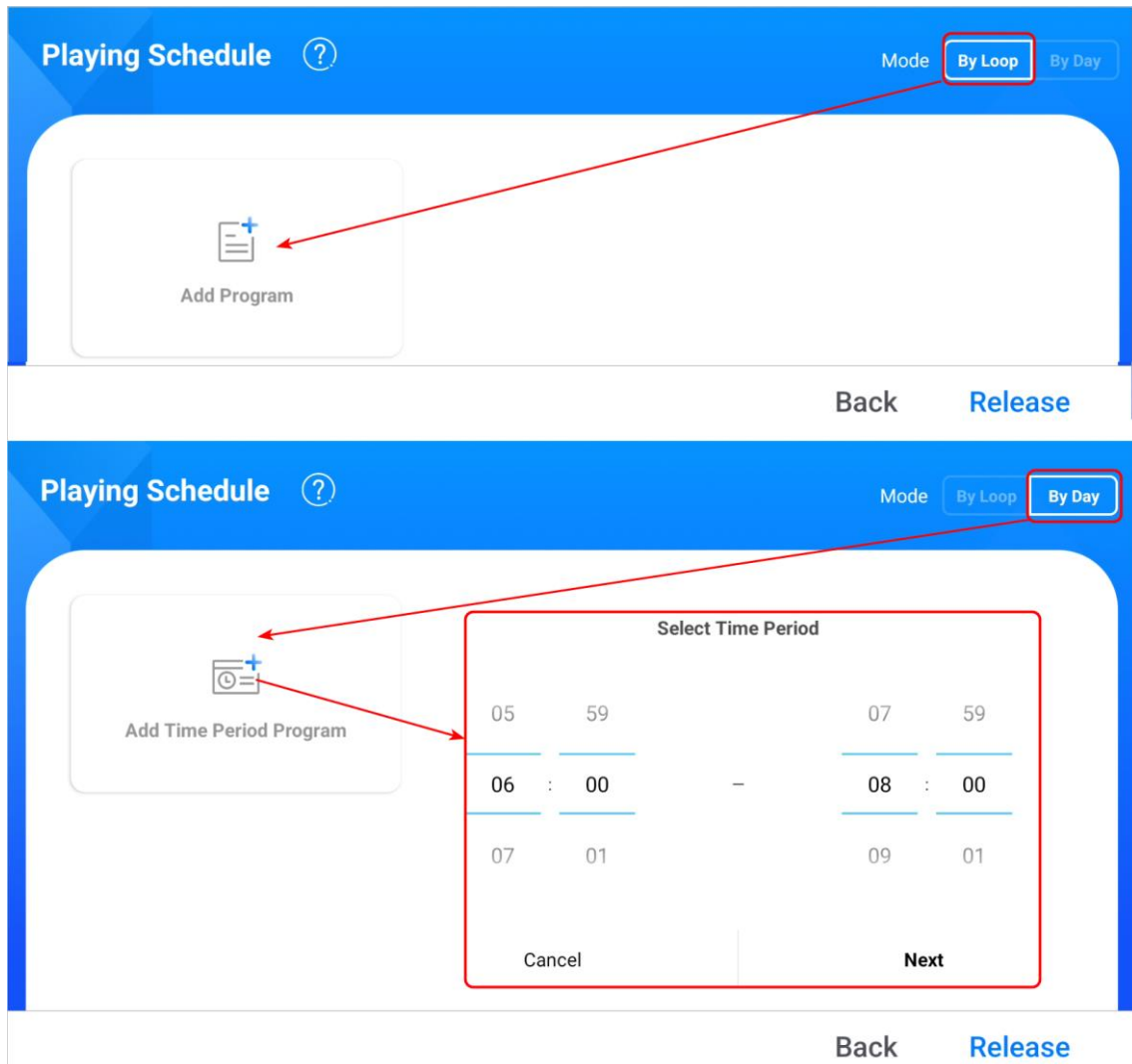

Figure 7-12 Select a Mode

Step 3 Add materials:

- 1) Click **Add Material**, and then select video or picture.

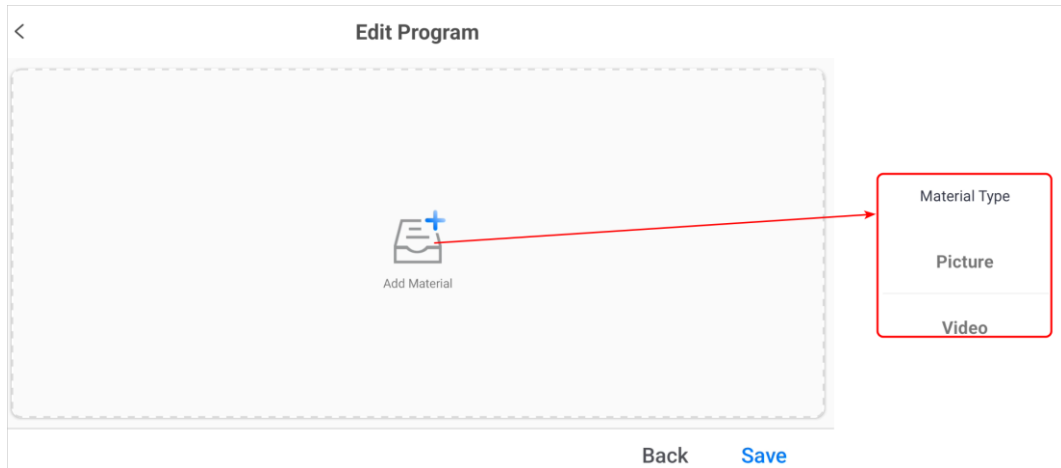

Figure 7-13 Select Material Type

- 2) Select materials from internal storage, set the duration of each material, and set the switching effect, click **OK**.

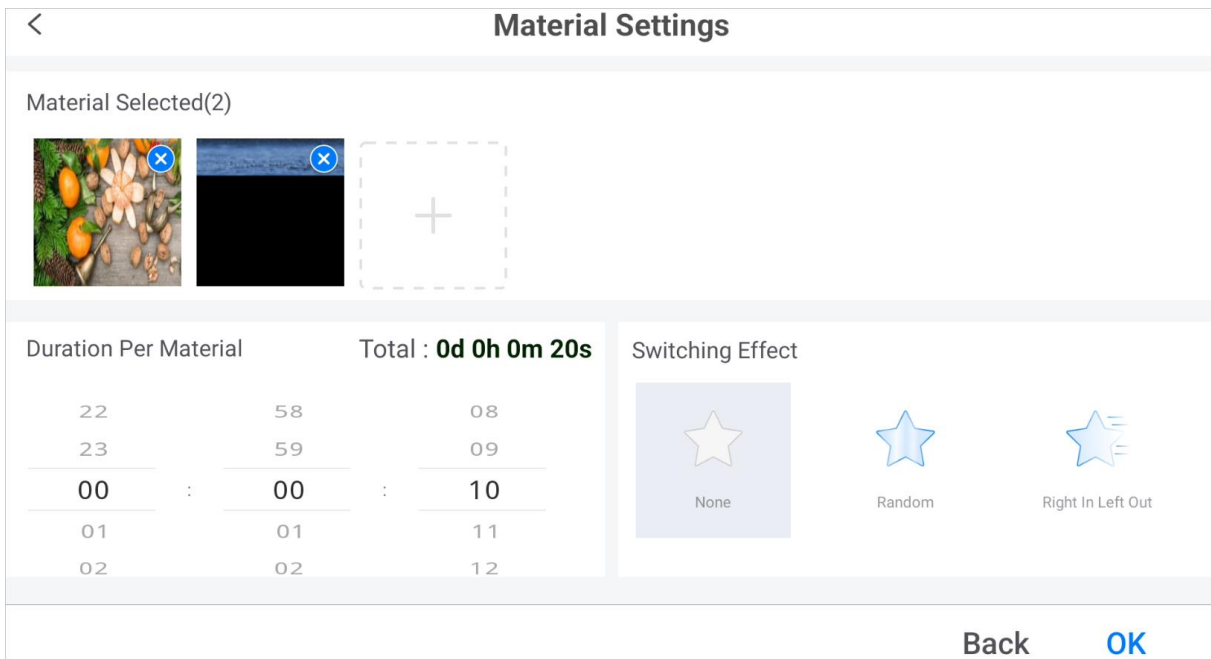

Figure 7-14 Add Materials

Step 4 Click **Save**.

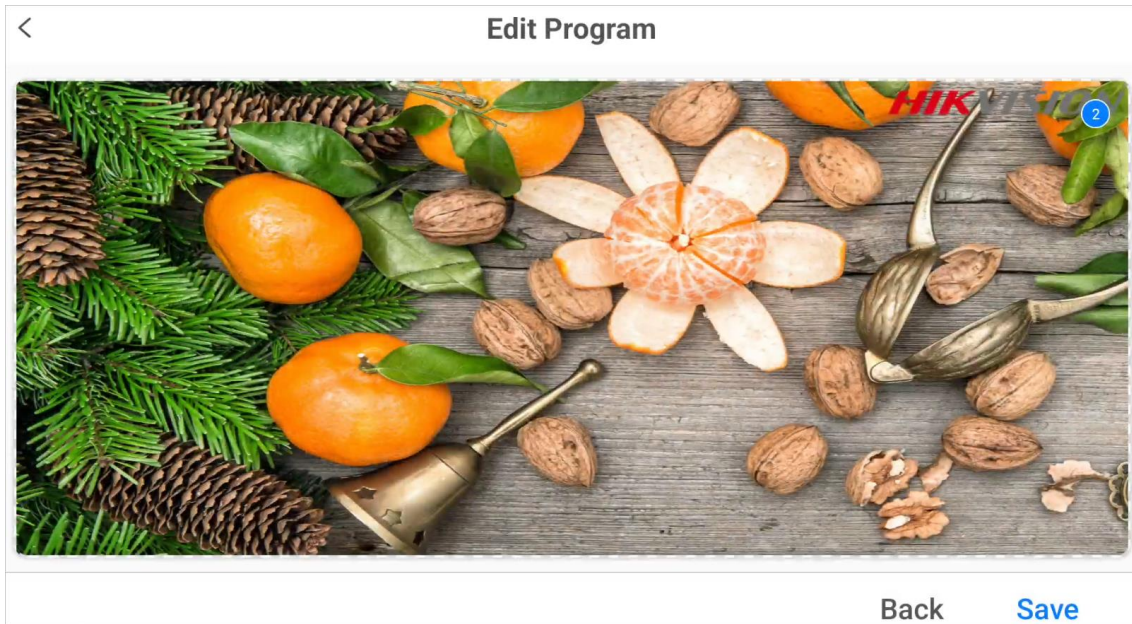



Figure 7-15 Save Program Configuration

Step 5 (Optional) You can perform the following operations as required:

- Repeat the above steps to create multiple programs.
- Click  in the upper right corner of a program to delete the program.
- Click a program to edit its material, duration or switching effect.
- For a program played by day, you can click  to edit the time period for the program.

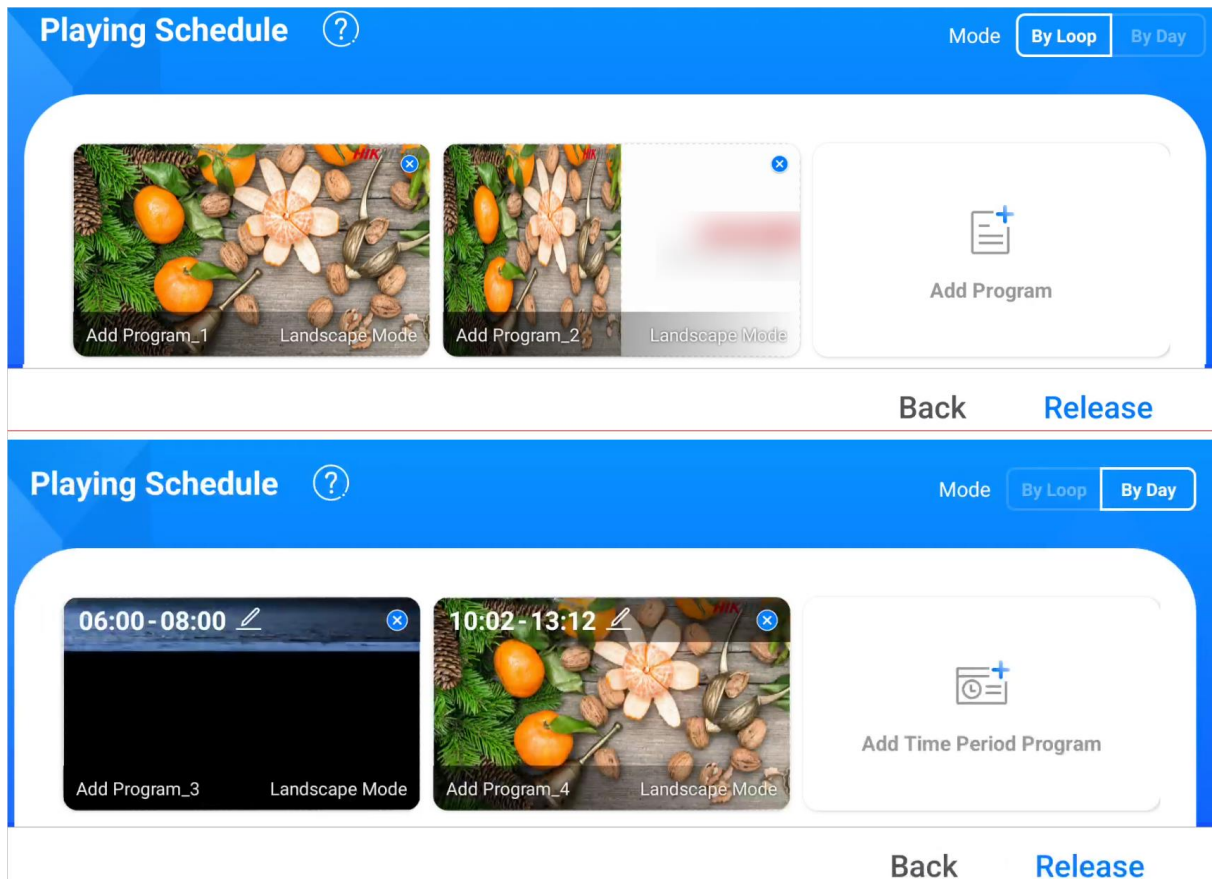





Figure 7-16 Manage Programs

Step 6 Click **Release**.

7.2.4 Edit Device Parameters

Note

- Click  to enter the parameter setting page.
- Right click the mouse to exit the current application or current page.

Click  on the FocSign Player page to enter the main page, and then click **Setting** or click  in the lower right corner of the main page to enter the **Setting** page. You can set the following device parameters as required:

- On the **Network** page, set the wired network, WLAN, hotspot, or Bluetooth. If the device is connected to both a wired and wireless network simultaneously, it will prioritize the wired network.

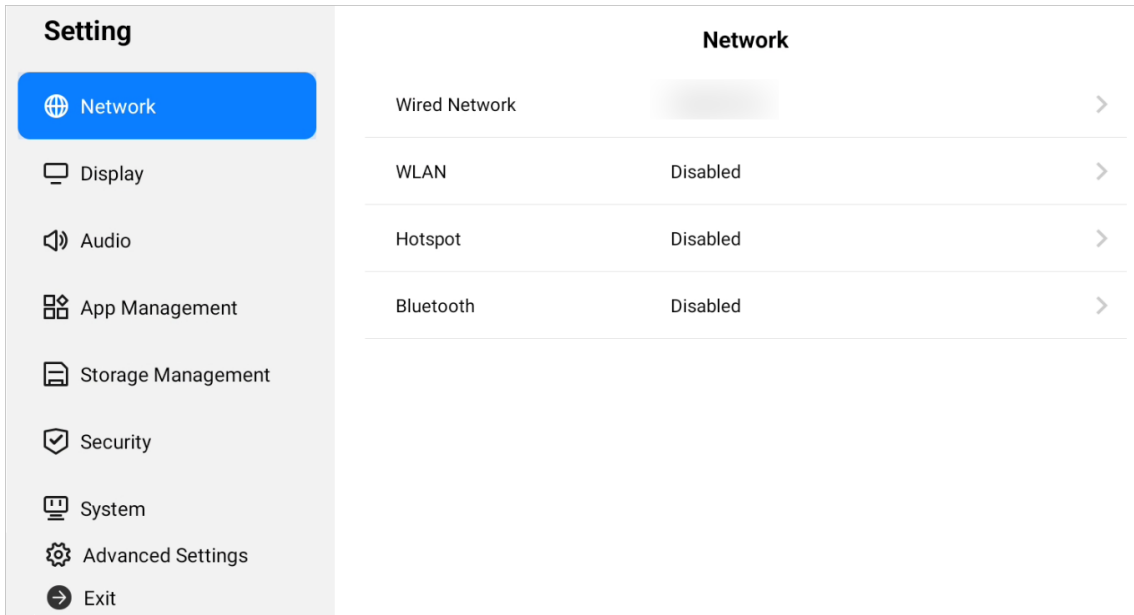





Figure 7-17 Set Network Parameters

- Click  of the wired network, enable static IP as required, and set the automatically obtained IP address or an unused IP address from the local network as the wired network address of the device.
- Click  of the WLAN, and enable WLAN. Click a wireless network, and enter the connection password to join the wireless network. Click  to view the wireless network address of the device. Click  and click **Clear Network** to disconnect the device from the wireless network.

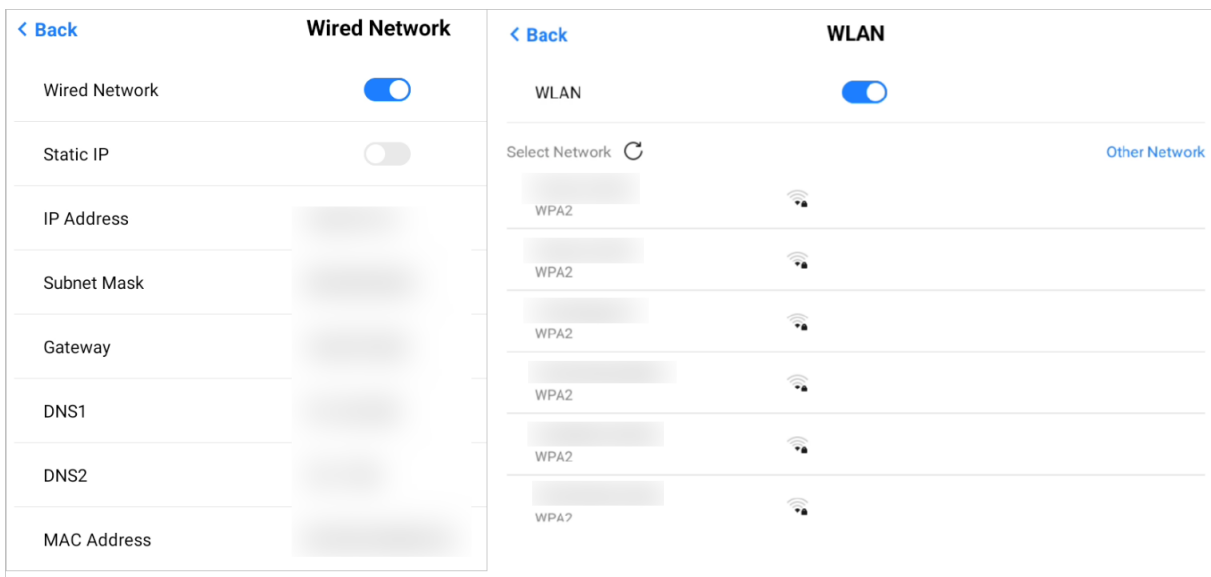

Figure 7-18 Set Wired and Wireless Network

- On the **Display** page, set HDMI output, screen rotation, font size, notification bar, navigation bar, or wallpaper.

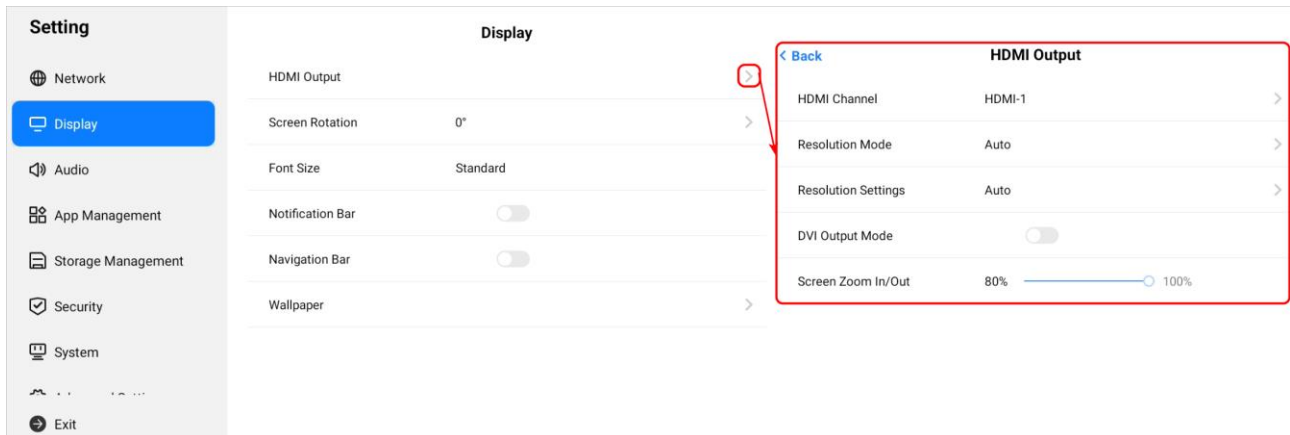







Figure 7-19 Set Display Parameters

- Click  of the HDMI output to set the HDMI channel, resolution mode, resolution settings, DVI output mode, or screen zoom in/out.
- After enabling navigation bar, you can click  to go back to previous menu, click  to return to the homepage application page, and click  to show the opened applications. You can click  to close the opened applications.

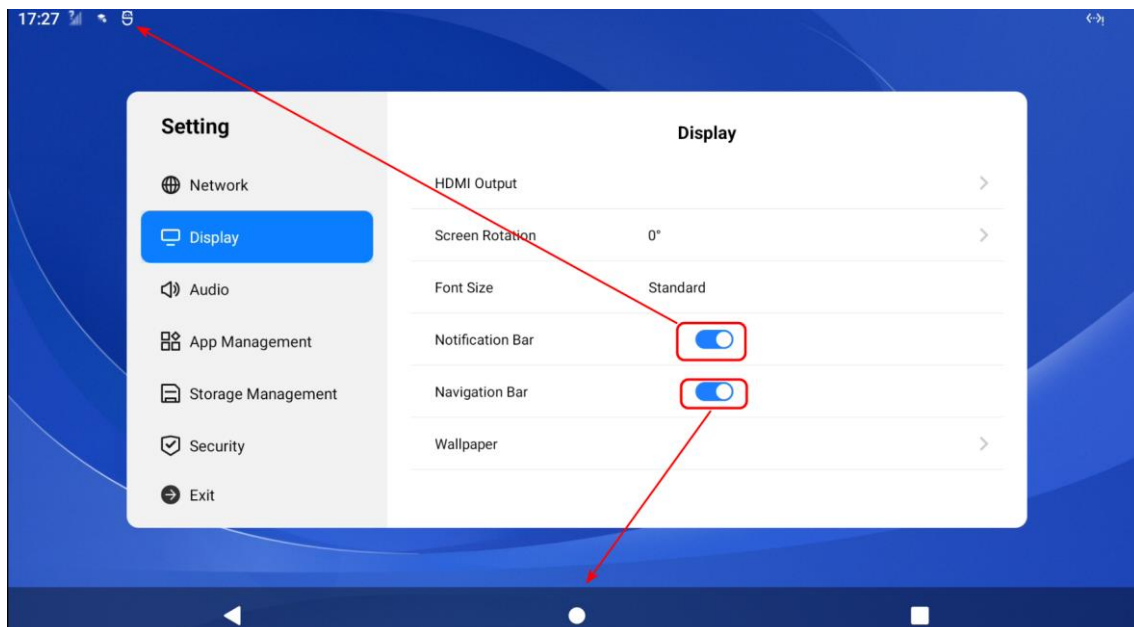

Figure 7-20 Set Notification Bar and Navigation Bar

- On the **Audio** page, set the volume.

- On the **App Management** page, enable run at startup, set default app, and show applications or system process.

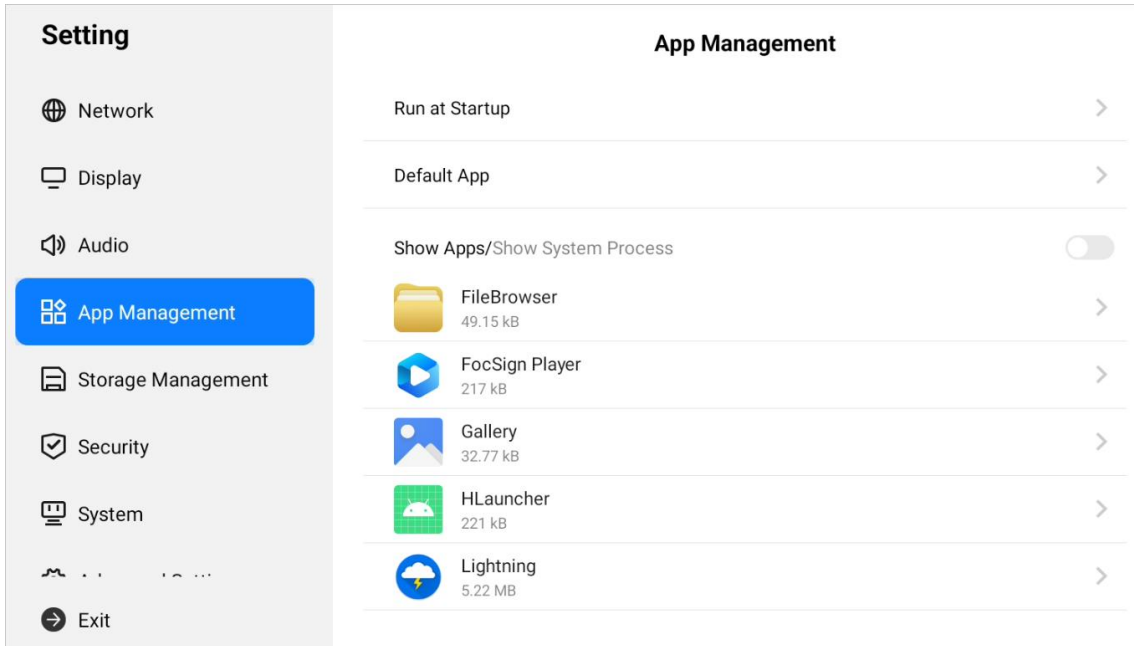

Figure 7-21 Manage Applications

- On the **Storage Management** page, view the internal shared storage, memory usage, and real-time memory usage. You can click **Release Space**.

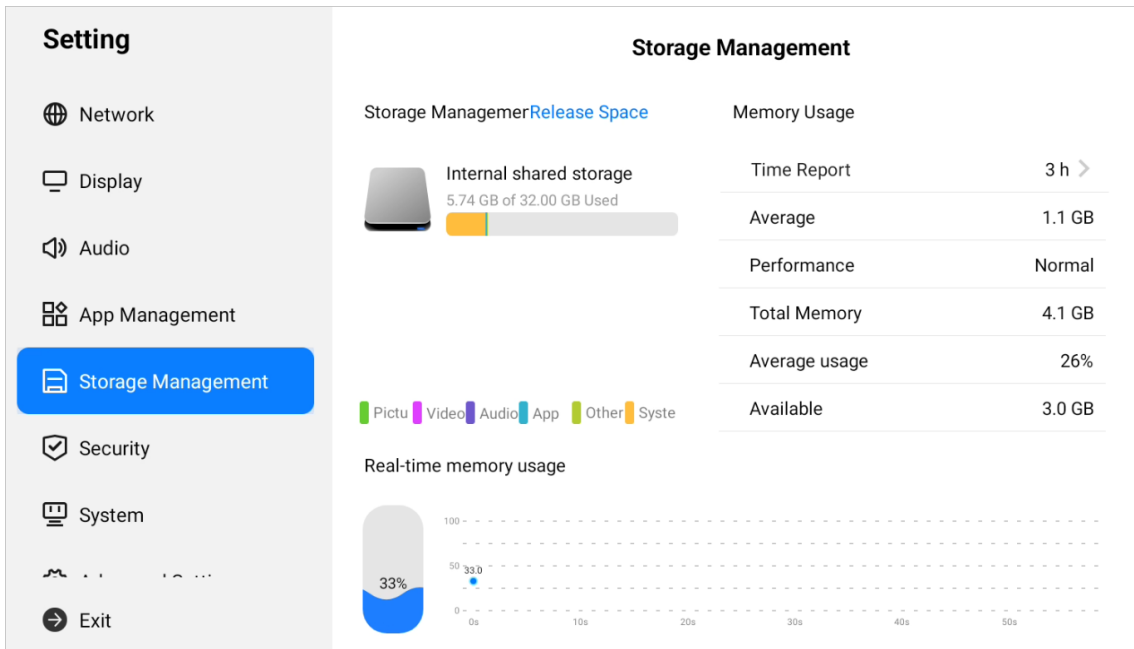

Figure 7-22 Manage Storage

- On the **Security** page, enable SADP and change the device activation status.

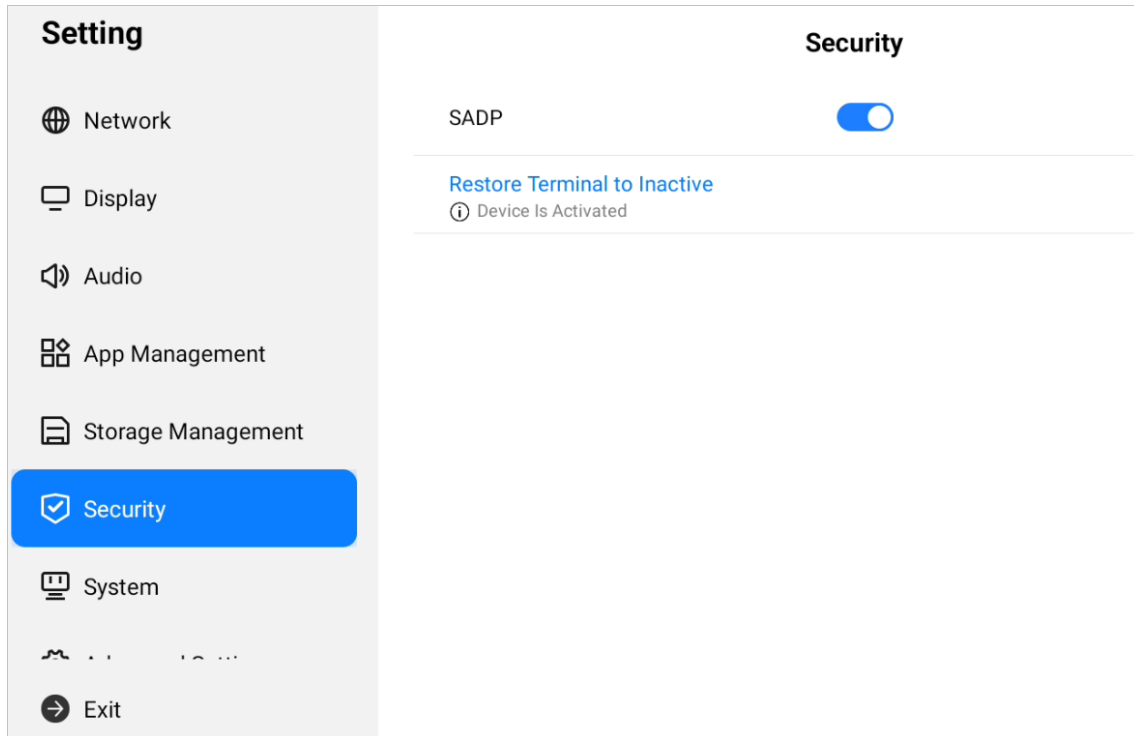

Figure 7-23 Set Security Parameters

- On the **System** page, view the basic system information, enable system debug, enable system log, restore the device to factory settings, or restart the device.

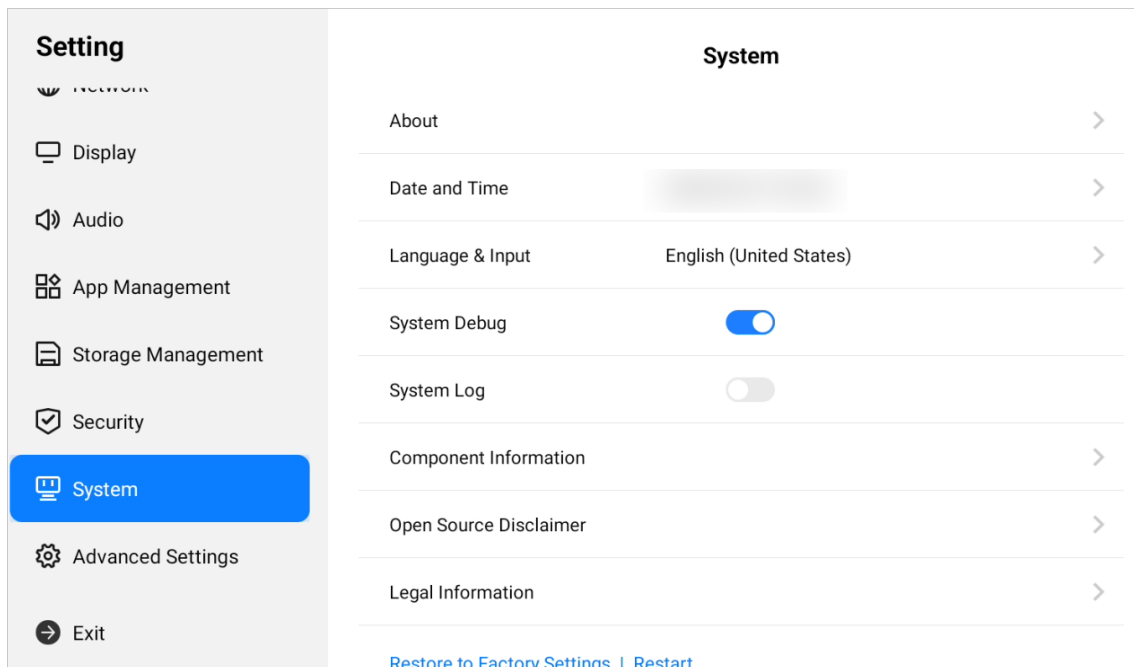

Figure 7-24 View System Parameters

- On the **Advanced Settings** page, set the scheduled startup.
 - 1) Enable scheduled startup.
 - 2) Click > of the startup/shutdown settings.

- 3) Set the startup time, shutdown time, and loop date, and click **OK**.
- 4) Enable the configured startup/shutdown schedule.

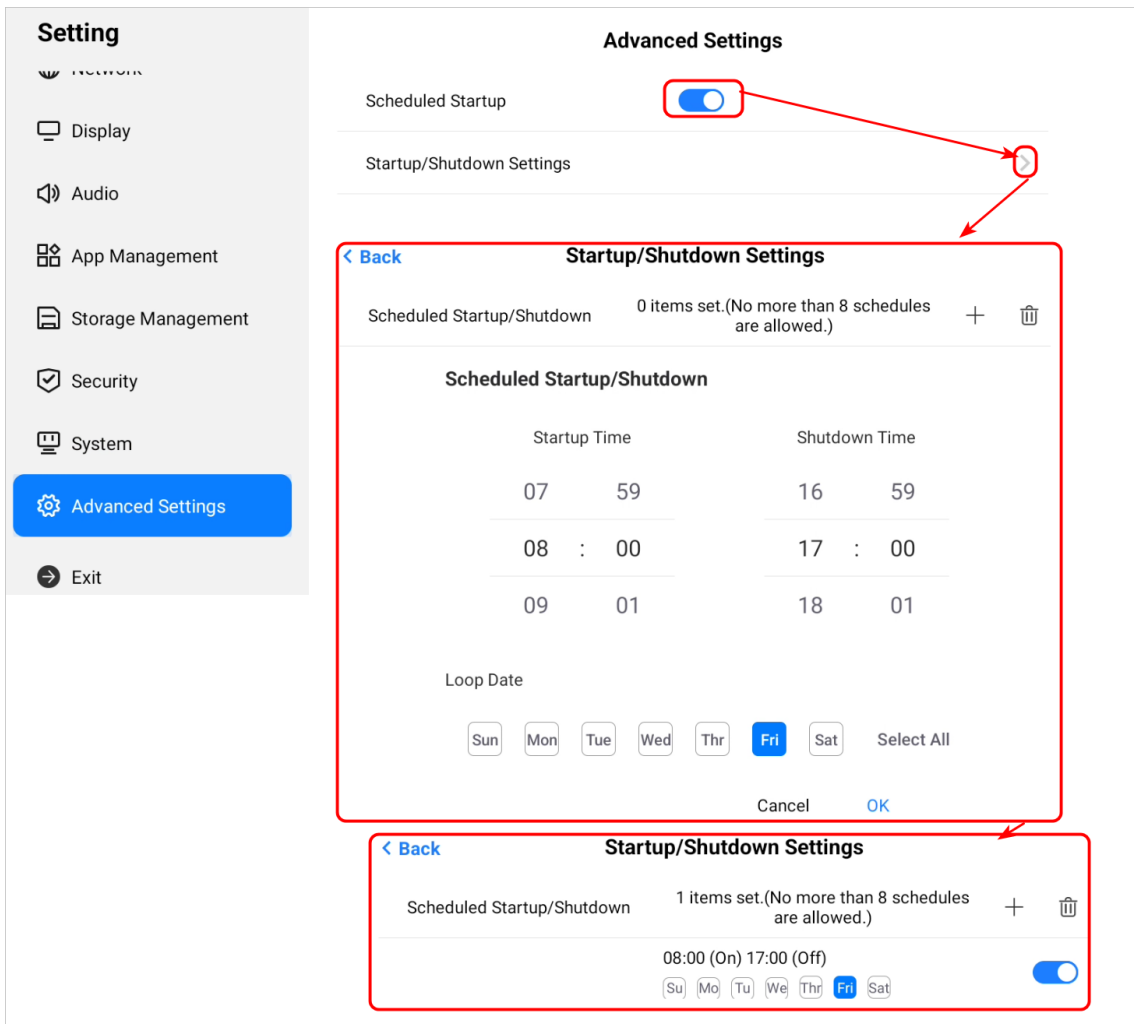
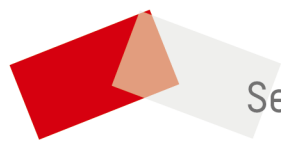

Figure 7-25 Set Scheduled Startup



See Far, Go Further